

SHURE®

LEGENDARY
PERFORMANCE™

SELECTION AND OPERATION

WIRELESS MICROPHONE SYSTEMS

Updated for digital wireless

By Tim Vear

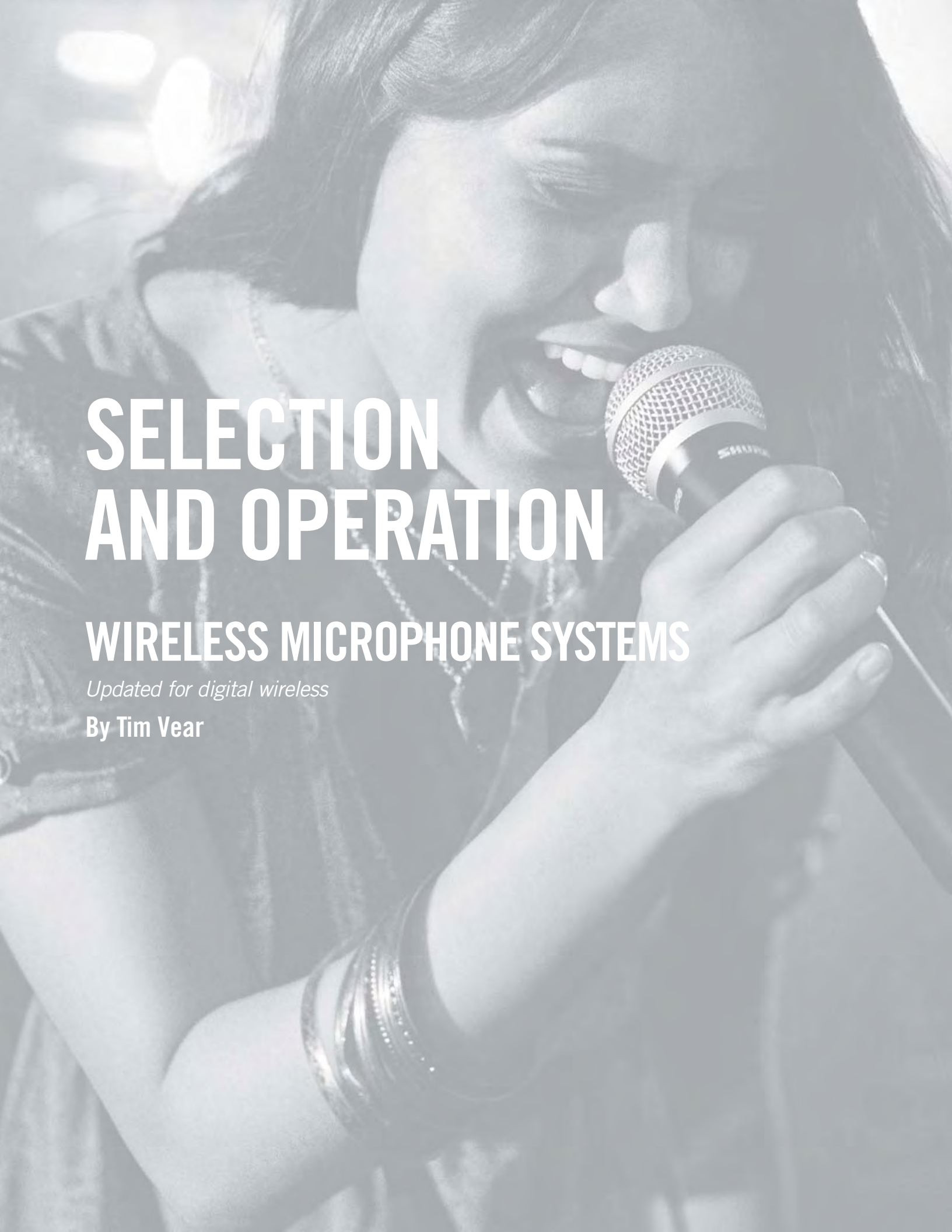

A Shure Educational Publication

A black and white photograph of a woman singing into a microphone. She is smiling and looking down at the microphone. The background is blurred, suggesting a stage or performance setting. The text is overlaid on the left side of the image.

SELECTION AND OPERATION

WIRELESS MICROPHONE SYSTEMS

Updated for digital wireless

By Tim Vear

Table of Contents

Introduction 4

Part One
Wireless Microphone Systems: How They Work

Chapter 1
Basic Radio Principles 5
 Radio Wave Transmission 5
 Radio Wave Modulation 7

Chapter 2
Basic Radio Systems 8
 System Description 8
 Input Sources 8
 Transmitter: General Description 9
 Transmitter: Audio Circuitry 10
 Transmitter: Radio Circuitry 11
 Receiver: General Description 12
 Receiver: Radio Circuitry 13
 Receiver: Audio Circuitry 14
 Receiver: Squelch 14
 Receiver: Antenna Configuration 15
 Multipath 15
 Receiver: Diversity Techniques 16
 Antennas 18
 Antenna Cable 20
 Antenna Distribution 21

Chapter 3
Wireless System Operation 23
 Frequency Bands for Wireless Systems 23
 VHF 23
 UHF 25
NEW Why UHF? 26
 Frequency Selection 26
 System Compatibility 26
 Operating Frequency Interactions:
 Intermodulation 26
 Internal Frequency interactions: LO, IF,
 Crystal Multipliers 28
 Non-System Radio Interference 30
 Broadcast Television 30
 Wireless Systems in the Post-DTV Transition Era 32
NEW White Space Devices 33
 Broadcast Radio 34

Other Radio Services 34
 Non-Broadcast Sources 34
 Range of Wireless Microphone Systems 35
 Spread Spectrum Transmission 35
 Digital Wireless Systems 36
 Operation of Wireless Systems Outside of the U.S. 39

Part Two
Wireless Microphone Systems: How To Make Them Work

Chapter 4
Wireless System Selection and Setup 40
 System Selection 40
 Crystal Controlled vs. Frequency Synthesis 41
 System Setup: Transmitter 41
 System Setup: Receivers 43
 System Setup: Receiver Antennas 45
 System Setup: Batteries 46
 System Checkout and Operation 47
 Computer-Controlled Wireless Systems 48
NEW “Intelligent” Wireless Systems 48
 Troubleshooting Wireless Microphone Systems 49
 Troubleshooting Guide 49

Chapter 5
Application Notes 50
 Presenters 50
 Musical Instruments 50
 Vocalists 51
 Aerobic/Dance Instruction 52
 Theater 52
 Worship 53
 Bingo 53
 Film/Videography 54
 Broadcast 54
 Point-to-Point Wireless 55
 Conclusion 58

Reference Information
 Appendix A: Calculation of
 Intermodulation Products 59
 Appendix B: U.S. Television Channels 61
 Glossary of Terms and Specifications 62
 Included Illustrations 65
 Biography 66

Wireless



Selection and Operation of WIRELESS Microphone Systems

Introduction

In the 60 years since their introduction, wireless microphone systems have developed from experimental devices to the present range of proven technologies. At the same time their use has evolved from a mere performance novelty to a universal feature in productions of every type. Finally, a steadily improving ratio of performance vs. cost has ultimately made the wireless microphone as affordable as it is reliable.

However, even as wireless products have become more capable and accessible, they are being used in ever more complex applications. In addition, the radio environment has become much more crowded and problematic than before. Advances such as digital technology have helped to meet these changing requirements, but challenges are likely to increase. As a result, even simple wireless microphone applications must be designed and installed with care to insure their successful operation.

The scope of this guide is limited to wireless systems used primarily in audio applications. Although most of the examples are given in terms of wireless microphones, the same radio and audio principles apply to wireless in-ear monitors, wireless intercoms, and other similar audio transmission systems. The reader is presumed to be somewhat familiar with typical audio systems. However, while there are

some similarities between sound transmission and radio transmission, many of the characteristics of radio systems are neither analogous to audio systems nor intuitive to the audio engineer. Therefore, some necessary basic radio principles are included in the presentation.

The purpose of this guide is to provide the interested reader with adequate information to select suitable wireless equipment for a given application and to use that equipment successfully. In addition, it is hoped that the fundamentals presented here will equip regular users of wireless with a framework to assist in their further understanding of this evolving technology.

This guide is presented in two parts: how wireless microphone systems work and how to make wireless microphone systems work. The first part is a technical introduction to the basic principles of radio and to the characteristics of wireless transmitters and receivers. The second part discusses the practical selection and operation of wireless microphone systems for general and specific applications. The two parts are intended to be self-contained. The first part should be of interest to those who specify or integrate professional wireless equipment while the second part should be of use to anyone who regularly works with wireless microphone systems.

Introduction



CHAPTER ONE

BASIC RADIO PRINCIPLES

Radio Wave Transmission

Radio refers to a class of time-varying electromagnetic fields created by varying voltages and/or currents in certain physical sources. These sources may be "artificial," such as electrical power and electronic circuits, or "natural," such as the atmosphere (lightning) and stars (sunspots). The electromagnetic field variations radiate outward from the source forming a pattern called a radio wave. Thus, a radio wave is a series of electromagnetic field variations travelling through space. Although, technically, any varying source of voltage or current produces a varying field near the source, here the term "radio wave" describes field variations that propagate a significant distance away from the source.

A sound wave has only a single "field" component (air pressure). Variations in this component create a pattern of air pressure changes along the direction the sound wave travels but otherwise have no particular orientation. In contrast, a radio wave includes both an electric field component and a magnetic field component. The variations in these components have the same relative pattern along the direction the radio wave travels but they are oriented at a 90 degree angle to each other as illustrated in Figure 1-1. In particular, it is the orientation of the electric field component which determines the angle of "polarization" of the radio wave. This becomes especially important in the design and operation of antennas.

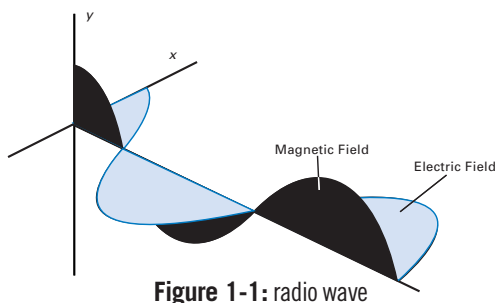

Figure 1-1: radio wave

Like sound waves, a radio wave can be described by its frequency and its amplitude. The frequency of a radio wave is the time rate of the field variations measured in Hertz (Hz), where 1 Hz equals 1 cycle-per-second. The radio spectrum, or range of frequencies, extends from a few Hertz through the KiloHertz (KHz) and Megahertz (MHz) ranges, to beyond the Gigahertz (GHz) range. The suffixes KHz, MHz, and GHz refer to thousands, millions, and billions of cycles-per-second respectively. As far as is

presently known, humans are directly sensitive to radio waves only at frequencies in the range of a few million GHz, which are perceived as visible light, and at those frequencies in the range just below visible light, which are perceived as heat (infrared radiation). The overall radio spectrum includes both natural and artificial sources as indicated by Figure 1-2.

The amplitude of a radio wave is the magnitude of the field variations. It is the characteristic that determines the "strength" of the radio wave. Specifically, it is defined to be the amplitude of the electric field variation. It is measured in volts per unit length and ranges from nanovolts/meter (nV/m) to kilovolts/meter (KV/m), where nV refers to one billionth of a volt and KV refers to one thousand volts. The minimum level required for pickup by a typical radio receiver is only a few tens of microvolts (uV, a millionth of a volt) but much higher levels can be found near transmitters and other sources. The wide range of radio wave amplitudes that may be encountered in typical applications requires great care in the design and use of wireless microphone systems, particularly receivers.

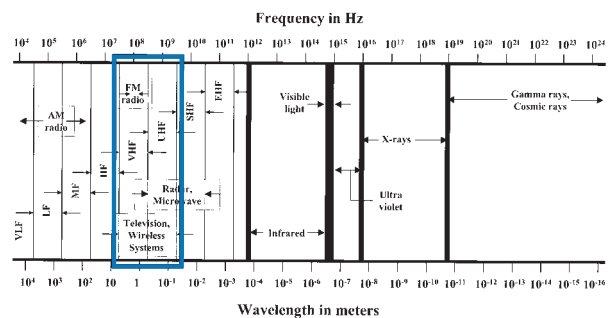

Figure 1-2: frequency vs. wavelength

Another characteristic of waves, related to frequency, is wavelength. The wavelength is the physical distance between the start of one cycle and the start of the next cycle as the wave moves through space. Wavelength is related to frequency by the speed at which the wave travels through a given medium. This relationship is expressed in the wave equation, which states that the speed of the wave is always equal to the product of the frequency times the wavelength. The wave equation applies to any physical wave phenomenon such as radio waves, sound waves, seismic waves, etc. (See Figure 1-3.)

The speed of radio waves (through a vacuum) is equal to approximately 3×10^8 meter/second, or about 186,000 miles/second. This is also known as the "speed of light," since light is just one part of the radio spectrum. The wave equation states that the frequency of a radio wave, multiplied by its wavelength always equals the speed of

Selection and Operation of WIRELESS Microphone Systems

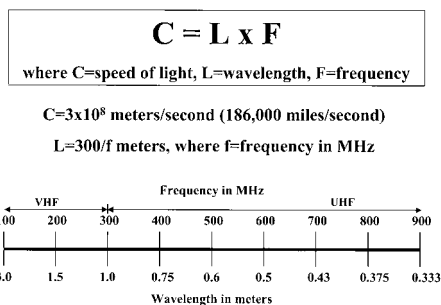

Figure 1-3: the wave equation

light. Thus, the higher the radio frequency, the shorter the wavelength, and the lower the frequency, the longer the wavelength. Typical wavelengths for certain radio frequencies are given in Figure 1-3. Wavelength also has important consequences for the design and use of wireless microphone systems, particularly for antennas.

Unlike sound, radio waves do not require a physical substance (such as air) for transmission. In fact, they "propagate" or travel most efficiently through the vacuum of space. However, the speed of radio waves is somewhat slower when travelling through a medium other than vacuum. For example, visible light travels more slowly through glass than through air. This effect accounts for the "refraction" or bending of light by a lens. Radio waves can also be affected by the size and composition of objects in their path. In particular, they can be reflected by metal objects if the size of the object is comparable to or greater than the wavelength of the radio wave. Large surfaces can reflect both low frequency (long wavelength) and high frequency (short wavelength) waves, but small surfaces can reflect only high frequency (short) radio waves. (See Figure 1-5.)

Interestingly, a reflecting metal object can be porous, that is, it can have holes or spaces in it. As long as the holes are much smaller than the wavelength, the metal surface will behave as if it were solid. This means that screens, grids, bars, or other metal arrays can reflect radio waves whose wavelength is greater than the space between the array elements and less than the overall array size. If the space between elements is larger than the wavelength, the radio waves will pass through the array.

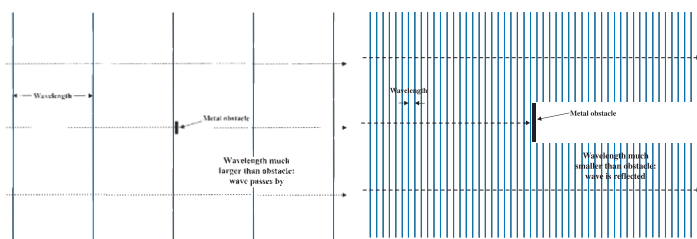

Figure 1-5: propagation: wavelength vs. obstacles.

For example, the metal grid on the glass door of a microwave oven reflects microwaves back into the oven but allows light waves to pass through so that the inside is visible. This is because microwaves have a wavelength of at least one centimeter while visible light has a wavelength of only one-millionth of a meter. (See Figure 1-4)

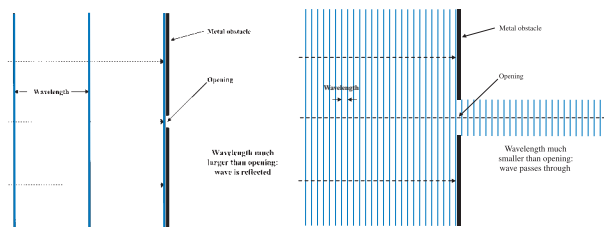

Figure 1-4: propagation: wavelength vs. openings.

Even metal objects that are somewhat smaller than the wavelength are able to bend or "diffract" radio waves. Generally, the size, location, and quantity of metal in the vicinity of radio waves will have significant effect on their behavior. Non-metallic substances (including air) do not reflect radio waves but are not completely transparent either. To some degree, they generally "attenuate" or cause a loss in the strength of radio waves that pass through them. The amount of attenuation or loss is a function of the thickness and composition of the material and also a function of the radio wavelength. In practice, dense materials produce more losses than lighter materials and long radio waves (low frequencies) can propagate greater distances through "lossy" materials than short radio waves (high frequencies). The human body causes significant losses to short radio waves passing through it.

An object that is large enough to reflect radio waves or dense enough to attenuate them can create a "shadow" in the path of the waves which can greatly hamper reception of radio in the area beyond the object.

A final parallel between sound waves and radio waves lies in the nature of the overall radio wave pattern or "field" produced by various sources at a given location. If reflections are present (which is nearly always the case indoors), the radio field will include both direct waves (those that travel by the shortest path from the source to the location) and indirect waves (those that are reflected). Radio waves, like sound waves, become weaker as they travel away from their source, at a rate governed by the inverse-square law: at twice the distance, the strength is decreased by a factor of four (the square of two). The strength of radio waves that arrive at a given location, by direct or indirect paths, is equal to the strength of

the original source(s) minus the amount of loss due to distance (inverse square loss), loss due to material attenuation, and loss due to reflections.

After many reflections radio waves become weaker and essentially non-directional. They ultimately contribute to ambient radio "noise," that is, general radio energy produced by many natural and man-made sources across a wide range of frequencies. The strength of ambient radio noise is relatively constant in a given area, that is, it does not diminish with distance. The total radio field at a given location consists of direct waves, indirect waves and radio noise.

Radio noise is nearly always considered to be undesirable. The direct and indirect waves may come from both the desired source (the intended transmission) and undesirable sources (other transmissions and general radio energy emitters). Successful radio reception depends on a favorable level of the desired transmission compared to the level of undesirable transmissions and noise.

Radio Wave Modulation

This discussion of radio transmission has so far dealt only with the basic radio wave. It is also necessary to consider how information is carried by these waves. Audio "information" is transmitted by sound waves which consist of air pressure variations over a large range of amplitudes and frequencies. This combination of varying amplitudes and varying frequencies creates a highly complex sound field. These varying pressure waves are able to be processed directly by our auditory systems to perceive speech, music, and other intelligible sounds (information).

Radio "information" is generally transmitted using only one frequency. This single electromagnetic wave is varied in amplitude, frequency, or some other characteristic (such as phase) and for most radio transmissions neither the wave nor its variation can be detected or processed directly by human senses. In fact, the wave itself is not the information but rather the "carrier" of the information. The information is actually contained in the amplitude variation or frequency variation, for example. When a radio wave contains information it is called a radio "signal." The general term for this information-carrying variation of radio waves is "modulation." If the amplitude of the wave is varied the technique is called Amplitude Modulation or AM. If the frequency is varied, it is called Frequency Modulation or FM. If the phase is varied, it is called Phase Modulation or PM.

The amount of information that can be carried in a radio signal depends on the type of modulation and the level of modulation that can be applied to the basic radio wave. It also

depends on the frequency of the basic radio wave. These factors are limited by physics to some extent, but are also limited by regulatory agencies such as the FCC. For AM signals, the radio wave has a single (constant) frequency of some basic amplitude (determined by the transmitter power). This amplitude is varied up and down (modulated) by the audio signal to create the corresponding radio signal. The rate of modulation is equal to the frequency of the audio signal and the amount of modulation is proportional to the amplitude (loudness) of the audio signal. The maximum (legal) amount of amplitude modulation allows an audio signal of only limited frequency response (about 50-9000 Hz) and limited dynamic range (about 50 dB). (See Figure 1-6.)

For FM signals, the radio wave has a constant amplitude (again determined by transmitter power) and a basic frequency. The basic radio frequency is varied up and down (modulated) by the audio signal to create the corresponding radio signal. This frequency modulation is called "deviation" since it causes the carrier to deviate up and down from its basic or unmodulated frequency. (See Figure 1-7.)

As with an AM signal, the rate of modulation is equal to the audio frequency and the amount of modulation is equal to the audio amplitude. Typical values of deviation in FM wireless microphone systems range from about 12KHz to 45KHz depending on the operating frequency band. The maximum (legal) amount of deviation allows an audio signal of greater frequency response (about 50-15,000 Hz) and greater dynamic range (more than 90 dB) than does AM.

Although the details of wireless microphone transmitters and receivers will be covered in the next section, it should be noted here that all of the systems discussed in this presentation use the FM technique. The reasons for this are the same as are apparent in commercial broadcast systems. More "information" can be sent in the typical FM signal, allowing higher fidelity audio signals to be transmitted. In addition, FM receivers are inherently less sensitive to many common sources of radio noise, such as lightning and electrical power equipment. These sources are characterized by a high level of AM-type noise which is rejected by FM systems.

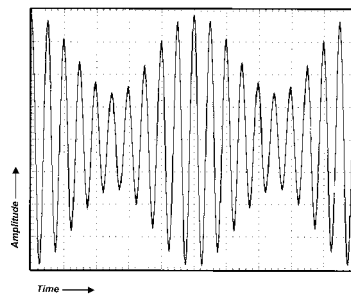

Figure 1-6: amplitude modulation (AM)

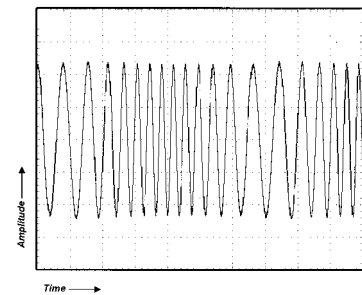

Figure 1-7: frequency modulation (FM)

CHAPTER TWO

BASIC RADIO SYSTEMS

System Description

The function of a radio or "wireless" system is to send information in the form of a radio signal. In this presentation, the information is assumed to be an audio signal, but of course video, data, or control signals can all be sent via radio waves. In each case, the information must be converted to a radio signal, transmitted, received, and converted back to its original form. The initial conversion consists of using the original information to create a radio signal by "modulating" a basic radio wave. In the final conversion, a complementary technique is used to "demodulate" the radio signal to recover the original information.

A wireless microphone system consists generally of three main components: an input source, a transmitter, and a receiver. (See Figure 2-1.) The input source provides an audio signal to the transmitter. The transmitter converts the audio signal to a radio signal and "broadcasts" or transmits it to the surrounding area. The receiver "picks up" or receives the radio signal and converts it back into an audio signal. Additional system components include antennas and, possibly, antenna cables and distribution systems. The processes and the basic components are functionally similar to commercial radio and television and other forms of radio communications. What differs is the component scale and the physical system configurations.

There are four basic configurations of wireless microphone systems, related to the mobility of the transmitter and receiver components, as required for different applications. The first configuration involves a portable transmitter and a stationary receiver. The transmitter is usually carried by the user, who is free to move about, while the receiver is located in a fixed position. The input source in this setup is normally a microphone or an electronic musical instrument. The receiver output is typically sent to a sound system, recording equipment, or a broadcast system. This is the configuration of the standard "wireless microphone" and is the arrangement most widely used in entertainment, public address, and broadcast applications.

The second configuration employs a stationary transmitter and a portable receiver. In this case, the user carries the receiver, while the transmitter is fixed. The input source to the transmitter for these setups is usually a sound system, playback system, or other installed source. The output of the receiver is typically monitored through headphones or loudspeakers. It may feed a portable

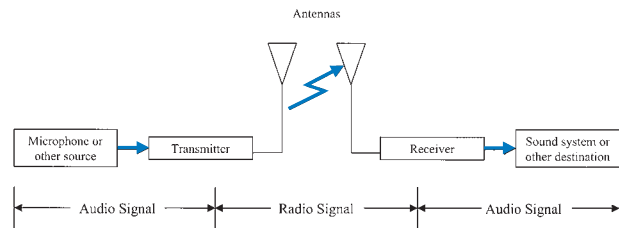

Figure 2-1: general radio system diagram

audio or video recorder. This is the configuration of wireless systems for in-ear-monitors, (IEMs) interruptible foldback systems (IFB), assistive listening, simultaneous translation, and various instructional uses. It is also, of course, the configuration of commercial radio and television broadcast systems when the receiver is mobile such as a personal radio or a car radio.

The third configuration consists of both a portable transmitter and a portable receiver. The users of both components are free to move about. Again, the input source is usually a microphone and the output is often a headphone. This is the configuration of "wireless intercom" systems, though each user in a typical setup has both a transmitter and a receiver for two-way communication. Another application of this configuration is for transmission of audio from a wireless microphone to a portable camera/recorder in broadcast, film, and videography.

The fourth configuration comprises a transmitter and a receiver that are each stationary. Such setups are often referred to as "point-to-point" wireless systems. The typical input would be a playback source or mixer while the output might be to a sound system or to a broadcast facility. Examples of this setup are wireless audio feeds to multiple amplifier/loudspeaker arrays for temporary distributed sound systems, radio remote-to-studio links and of course commercial and non-commercial broadcasts from fixed transmitters to fixed receivers.

Input Sources

The input source is any device that provides a suitable audio signal to the transmitter. "Suitable audio signal" means an electrical signal within a certain frequency range (audio), voltage range (microphone level or line level), and impedance range (low or high) that can be handled by the transmitter. Though this places some limits on input sources, it will be seen that almost any type of audio signal can be used with one system or another.

The most common input source is a microphone, which may take any one of a variety of forms: handheld, lavalier, headworn, instrument-mounted, etc. The audio

Selection and Operation of **WIRELESS** Microphone Systems

signal provided by this source is audio frequency, microphone level, and usually low impedance. Since the "wireless" part of the wireless microphone only serves to replace the cable, ideally, the characteristics and performance of a particular microphone should not change when used as part of a wireless microphone system.

Therefore, the selection of microphone type for a wireless microphone system should be made following the same guidelines as for wired microphones. The usual choices of operating principle (dynamic/condenser), frequency response (flat/shaped), directionality (omnidirectional/unidirectional), electrical output (balanced/unbalanced, low or high impedance), and physical design (size, shape, mounting, etc.) must still be made correctly. Problems that result from improper microphone choice will only be aggravated in a wireless application.

Another widely encountered input source is an electronic musical instrument, such as an electric guitar, electric bass, or portable electronic keyboard. The signal from these sources is again audio frequency, microphone or line level, and usually high impedance. The potentially higher signal levels and high impedances can affect transmitter choice and operation.

Finally, general audio signal sources such as mixer outputs, cassette or CD players, etc. may be considered. These exhibit a wide range of levels and impedances. However, as long as these characteristics are within the input capabilities of the transmitter they may be successfully used.

Transmitter: General Description

Transmitters can be either fixed or portable as mentioned earlier. Regardless of type, transmitters usually feature a single audio input (line or microphone type), minimal controls and indicators (power, audio gain adjustment) and a single antenna. Internally, they are also functionally the same, except for the power supply: AC power for fixed types and battery power for portable models. The important features of transmitter design will be presented in the context of portable units.

Portable transmitters are available in three different forms: bodypack, handheld, and plug-on. (See Figure 2-2.) Each of these has further variations of inputs, controls, indicators, and antennas. The choice of transmitter type is often dictated by the choice of input source: handheld microphones usually require handheld or plug-on transmitters while nearly all other sources are used with bodypack types.

Bodypack (sometimes called belt-pack) transmitters are typically packaged in a shirt-pocket sized rectangular housing. They are often provided with a clip that secures to clothing or belt, or may be placed in a pocket or pouch. In theater and some other applications they may be concealed

underneath clothing. Input is made from the source to the bodypack via a cable, which may be permanently attached or detachable at a connector. This connector may allow a variety of input sources to be used with one transmitter.

Bodypack transmitter controls include at least a power switch and often a separate mute switch, allowing the audio input to be silenced without interrupting the radio signal. Other controls may include gain adjustment, attenuators, limiters and, in tuneable systems, a provision for frequency selection. Indicators (usually LED's) for power-on and battery condition are desirable, while tuneable units sometimes include digital readouts of frequency. A few transmitters are equipped with audio "peak" indicators. Finally, the antenna for a bodypack transmitter may be in the form of a flexible attached wire, a short "rubber ducky" type, or the input source cable itself, such as a guitar cable or lavalier microphone cable.

Handheld transmitters, as the name implies, consist of a handheld vocal microphone element integrated with a transmitter built into the handle. The complete package appears only slightly larger than a wired handheld microphone. It may be carried in the hand or mounted on a microphone stand using an appropriate swivel adapter. Input from the microphone element is direct via an internal connector or wires. Some models have removable or interchangeable microphone elements.

Handheld transmitter controls are generally limited to a power switch, a mute switch, and gain adjustment. Again, tuneable models include some provision for frequency selection. Indicators are comparable to those in bodypack transmitters: power status, battery condition, frequency. Handheld transmitter antennas are usually concealed internally, though certain types (primarily UHF) may use a short external antenna.

"Plug-on" transmitters are a special type designed to attach directly to a typical handheld microphone, effectively allowing many standard microphones to become "wireless." The transmitter is contained in a small rectangular or cylindrical housing with an integral female XLR-type input connector.



Figure 2-2: examples of transmitters (left to right: handheld, bodypack, plug-on)

Selection and Operation of

WIRELESS

Microphone Systems

Controls and indicators are comparable to those found in bodypack types and the antenna is usually internal.

Miniaturization of components has also resulted in a class of transmitters that are integrated directly into headworn microphones and lapel microphones as well as units that can plug directly into the output connector of an electric guitar. The trend toward smaller and more highly integrated devices is certain to continue.

While transmitters vary considerably in their external appearance, internally they all must accomplish the same task: use the input audio signal to modulate a radio carrier and transmit the resulting radio signal effectively. Though there are many different ways to engineer wireless transmitters, certain functional elements are common to most current designs. It is useful to describe these elements to gain some insight to the overall performance and use of wireless microphone systems. (See Figure 2-3.)

Transmitter: Audio Circuitry

The first part of the typical transmitter is the input circuitry. This section makes the proper electrical match between the input source and the rest of the transmitter. It must handle the expected range of input levels and present the correct impedance to the source. Gain controls and impedance switches allow greater flexibility in some designs. In certain cases, the input circuitry also provides electrical power to the source (for condenser microphone elements).

The signal from the input stage passes to the signal processing section, which optimizes the audio signal in several ways for the constraints imposed by radio transmission. The first process is a special equalization called pre-emphasis, which is designed to minimize the apparent level of high frequency noise (hiss) that is unavoidably added during the FM transmission. The "emphasis" is a specifically tailored boost of the high frequencies. When this is coupled with an equal (but opposite) "de-emphasis" in the receiver, the effect is to reduce high frequency noise by up to 30 dB. (See Figures 2-4 a & b.)

The second process is called "companding" (compress/ expand), which is designed to compensate for the limited dynamic range of radio transmission. The part of the process performed in the transmitter is "compression," in which the dynamic range of the audio signal is reduced or compressed, typically by a fixed ratio of 2:1. Again, when this is coupled with an equal but opposite (1:2) "expansion" of the signal in the receiver, the original dynamic range of the audio signal is restored. A voltage-controlled-amplifier (VCA) is the circuit element that provides both dynamic functions: gain is decreased in the compressor mode and increased in the expander

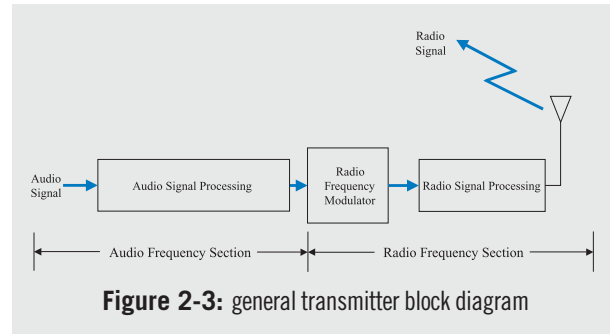

mode. The gain change is proportional to the signal level change. Nearly all current wireless microphone systems employ some form of companding, allowing a potential dynamic range greater than 100 dB. (See Figure 2-5a.)

A variation that is found in a few compander designs is to divide the audio signal into two or more frequency bands. Each band is then pre-emphasized and compressed independently. In the receiver, de-emphasis and expansion are applied separately to these same bands before combining them back into a full-range audio signal. Though more expensive, multi-band companding systems may have a better ability to improve dynamic range and apparent signal-to-noise ratio across the entire audio range.

A limitation of fixed-ratio companders is that the same amount of signal processing is applied regardless of signal level. Dynamics processors perform compression or

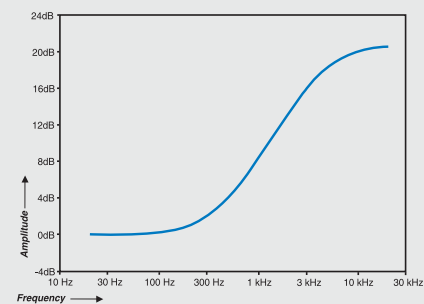

Figure 2-4a: pre-emphasis in transmitter

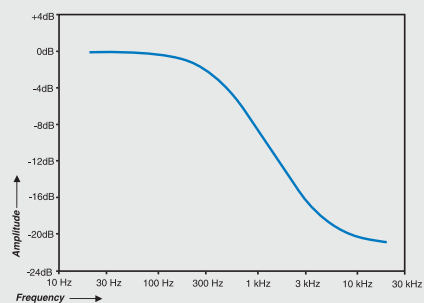

Figure 2-4b: de-emphasis in receiver

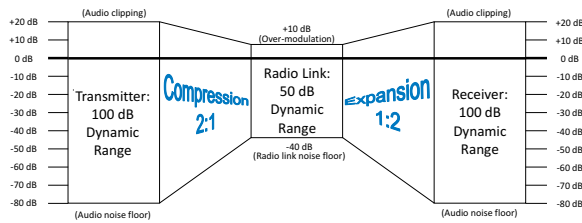

Figure 2-5a: compander (2:1, fixed rate)

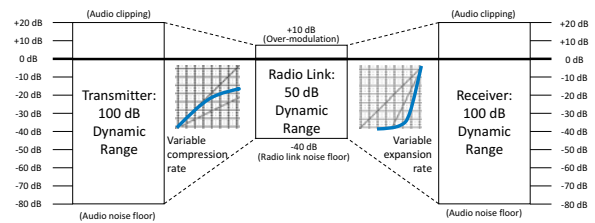

Figure 2-5b: compander (variable)

expansion functions based on an evaluation of the "average" signal level, which fluctuates continuously. Because this process is not instantaneous, the compander action is not completely transparent. With good design, audible "artifacts" are minimal but may become more apparent when the signal level is extremely low. This accounts for occasional "modulation" noise or background noise intrusion that accompanies low-level audio signals, especially when the radio signal itself is weak or noisy.

The performance of full-band companding systems can be improved by first optimizing the measurement of the average signal level. A "true RMS" detector is preferred, since this technique most closely tracks the amplitude of a full range audio signal, regardless of frequency response. Further improvement can be realized by using level-dependent companding. For low level audio signals, little or no processing is applied so there are no audible effects. As the audio signal level increases, processing levels are increased, so that potentially audible artifacts are masked. Implementation of this scheme requires a high performance VCA and close tolerance in the audio sections of transmitters and receivers. (See Figure 2-5b.)

In many transmitters, an additional process called limiting is applied to the audio signal. This is to prevent overload and distortion in subsequent audio stages or to prevent "overmodulation" (excessive frequency deviation) of the radio signal. The "limiter" automatically prevents the audio signal level from exceeding some preset maximum level and is usually applied after pre-emphasis and companding.

The audio processing described here is generally done with analog circuitry. It is also possible to implement companding using digital signal processing (DSP). These "hybrid" systems transmit an analog RF signal but the audio path in the transmitter and/or receiver passes through DSP circuitry.

Transmitter: Radio Circuitry

After processing, the audio signal is sent to a voltage-controlled oscillator (VCO). This is the section that actually converts the audio signal to a radio signal by the technique called frequency modulation (FM). The (relatively) low frequency audio signal controls a high frequency oscillator to produce a radio signal whose frequency

"modulates" or varies in direct proportion to the audio signal.

The maximum value of modulation is called the deviation and is specified in kilohertz (KHz). The amount of deviation produced by the audio signal is a function of the design of the transmitter. Systems with deviation greater than the modulating frequency are called wideband, while systems with deviation less than the modulating frequency are called narrow band. Most wireless microphone transmitters fall into the lower end of the wideband category. (See Figures 2-6 a & b.)

The "base" or unmodulated frequency of the oscillator for a single frequency system is fixed. Historically, the frequency of the signal from the VCO (for a conventional, crystal-controlled transmitter) was much lower than the desired output frequency of the transmitter. In order to achieve a given transmitter frequency the output from the VCO was put through a series of frequency multiplier stages. These multipliers were usually a combination of doublers, triplers, or even quadruplers. For example, a transmitter

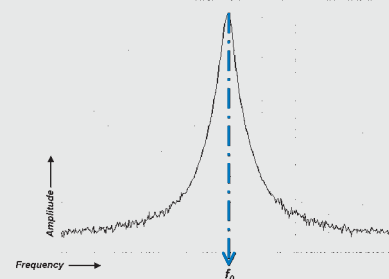

Figure 2-6a: unmodulated FM signal spectrum

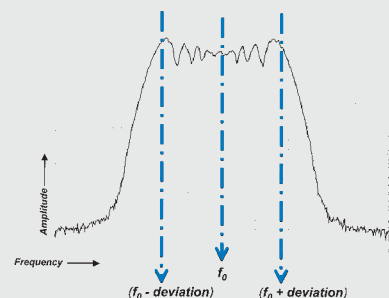

Figure 2-6b: modulated FM signal spectrum

Selection and Operation of WIRELESS Microphone Systems

that employs two triplers (for a 9x multiplication) would use a VCO with a base frequency of 20 MHz to achieve a 180 MHz transmitted frequency. The multipliers also function as amplifiers so that the output signal is at the desired power level as well. (See Figure 2-7.)

A few tuneable transmitters use multiple crystals to obtain multiple frequencies. Today, however, the base frequency of the VCO for most tuneable systems is adjustable by a technique known as frequency synthesis. A control circuit called a phase-locked-loop (PLL) is used to calibrate the transmitter frequency to a reference "clock" frequency through an adjustable frequency divider. By changing the divider in discrete steps, the transmitter frequency can be precisely varied or tuned over the desired range. Frequency-synthesized designs allow the audio signal to modulate the VCO directly at the transmitter frequency. No multiplier stages are required. (See Figure 2-8.)

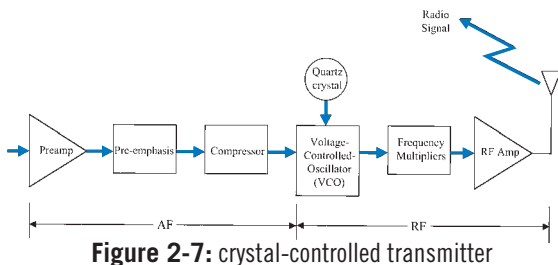

Figure 2-7: crystal-controlled transmitter

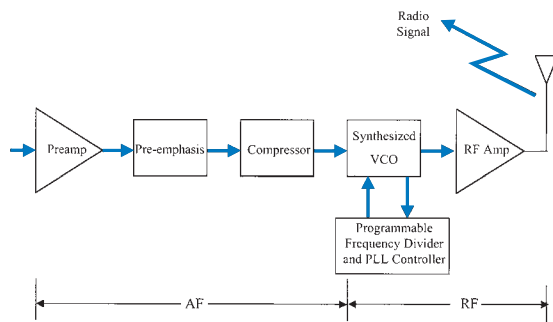

Figure 2-8: frequency-synthesized transmitter

The last internal element of the transmitter is the power supply. For portable transmitters, power is generally supplied by batteries. Since the voltage level of batteries falls as they are discharged, it is necessary to design the device to operate over a wide range of voltage and/or to employ voltage-regulating circuitry. Most designs, especially those requiring a 9 V battery, use the battery voltage directly. Others, typically those using 1.5 V cells, have DC-to-DC converters that boost the low voltage up to the desired operating value. Battery life varies widely among transmitters, from just a few hours up to twenty hours, depending on output power, battery type, and overall circuit efficiency.

Receiver: General Description

Receivers are available in both fixed and portable designs. (See Figure 2-9.) Portable receivers resemble portable transmitters externally: they are characterized by small size, one or two outputs (microphone/line, head-phone), minimal controls and indicators (power, level), and (usually) a single antenna. Internally they are functionally similar to fixed receivers, again with the exception of the power supply (battery vs. AC). The important features of receivers will be presented in the context of fixed units, which exhibit a greater range of choices.

Fixed receivers offer various outward features: units may be free standing or rack-mountable; outputs may include balanced/unbalanced microphone or line level as well as headphones; indicators for power and audio/radio signal level may be present; controls for power and output level are usually offered; antennas may be removable or permanently attached. Like transmitters, receivers can vary greatly in packaging, but inside they must achieve a common goal: receive the radio signal efficiently and convert it into a suitable audio signal output. Once again it will be useful to look at the main functional elements of the typical receiver. (See Figure 2-10.)

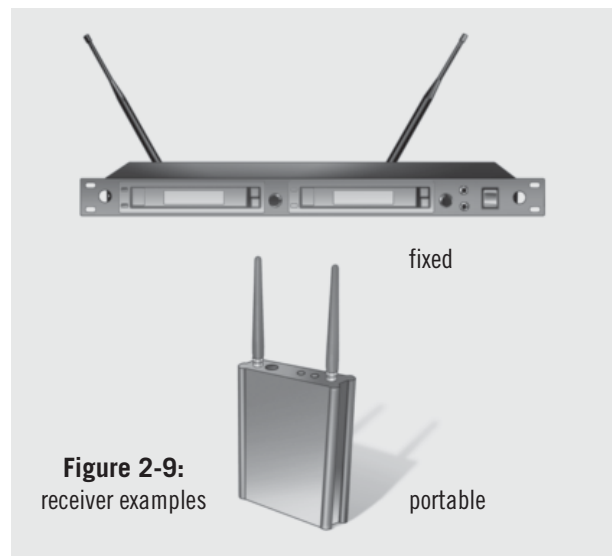

Figure 2-9: receiver examples

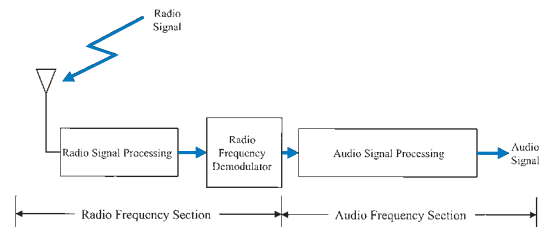

Figure 2-10: general receiver block diagram

Receiver: Radio Circuitry

The first section of receiver circuitry is the "front end." Its function is to provide a first stage of radio frequency (RF) filtering to prevent unwanted radio signals from causing interference in subsequent stages. It should effectively reject signals that are substantially above or below the operating frequency of the receiver. For a single frequency receiver the front end can be fairly narrow. For a tuneable receiver it must be wide enough to accommodate the desired range of frequencies if the front end filter itself is not tuneable.

In order to accommodate very wide tuning ranges, a track-tuned front-end filter is sometimes used. This is a relatively narrow filter that is automatically centered on the tuned frequency to prevent excessive off-channel radio energy from entering the receiver. (See Figure 2-11.)

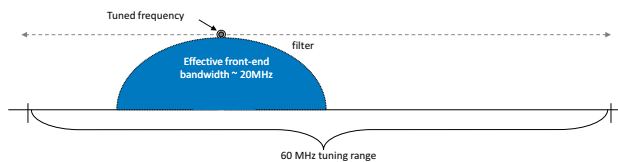

Figure 2-11: track tuning front-end filter

The second receiver section is the "local oscillator" (usually abbreviated as "LO"). This circuit generates a constant radio frequency that is related to the frequency of the received radio signal but differs by a "defined amount." Single frequency receivers have a fixed frequency local oscillator (LO), again using a quartz crystal. Tuneable receivers have an adjustable LO, which generally uses a frequency synthesis design. (See Figures 2-12 a & b.)

Next, the (filtered) received signal and the local oscillator output are input to the "mixer" section. The mixer, in a radio receiver, is a circuit that combines these signals in a process called "heterodyning." This process produces two "new" signals: the first new signal is at a frequency which is the sum of the received signal frequency and the local oscillator frequency, while the second is at a frequency which is the difference between the received signal frequency and the local oscillator frequency. Both the sum and the difference signals contain the audio information carried by the received signal. It should be noted that the LO frequency can be above or below the received frequency and still yield the same difference frequency when combined in the mixer. When the LO frequency is lower than the received frequency the design is called "low-side injection." When it is above it is called "high-side injection."

The sum and difference signals are then sent to a series of filter stages that are all tuned to the frequency of the difference signal. This frequency is the "intermediate frequency" (IF), so-called because it is lower than the

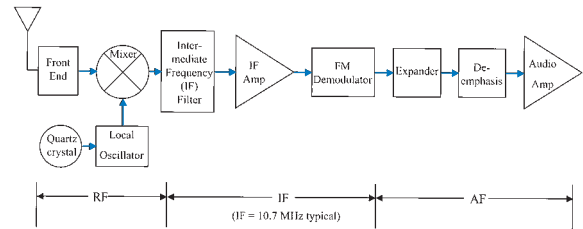

Figure 2-12a: single conversion, crystal-controlled receiver

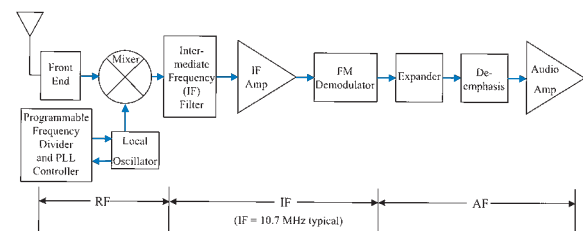

Figure 2-12b: single conversion, frequency-synthesized receiver

received radio frequency but still higher than the final audio frequency. It is also the "defined amount" used to determine the local oscillator frequency of the previous section. The narrowly tuned IF filters are designed to completely reject the sum signal, as well as the LO frequency and the original received signal, and any other radio signals that may have gotten through the front end. The IF filters allow only the difference signal to pass through. (See Figure 2-13.) This effectively converts the received radio frequency (RF) signal to the much lower intermediate frequency (IF) signal and makes subsequent signal processing more efficient. This overall process is called "downconversion."

If only one LO and one mixer stage are used then only one intermediate frequency is produced and the receiver is said to be a "single conversion" type. In a "double conversion" receiver the incoming signal is converted to the

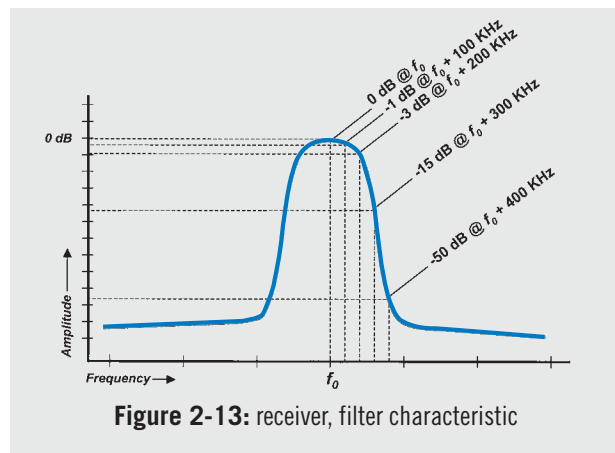

Figure 2-13: receiver, filter characteristic

Selection and Operation of WIRELESS Microphone Systems

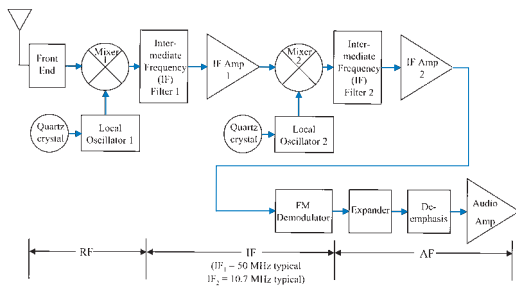

Figure 2-14a: double conversion, crystal-controlled receiver

final IF in two successive stages, each with its own LO and mixer. This technique can provide increased stability and interference rejection, though at significantly higher design complexity and cost. Double conversion is more common in UHF receiver designs where the received signal frequency is extremely high. (See Figures 2-14 a & b.)

The IF signal is finally input to the "detector" stage which "demodulates" or extracts the audio signal by one of several methods. One standard technique is known as "quadrature." When two signals are out of phase with each other by exactly 90 degrees they are said to be in quadrature. When such signals are multiplied together and low-pass filtered the resulting output signal consists only of frequency variations of the original input signal. This effectively eliminates the (high-frequency) carrier frequency leaving only the low-frequency modulation information (the original audio signal).

In a quadrature FM detector the IF signal passes through a circuit which introduces a 90 degree phase shift relative to the original IF signal. The phase-shifted IF signal is then multiplied by the straight IF signal. A low-pass filter is applied to the product, which results in a signal that is now the audio signal originally used to modulate the carrier in the transmitter.

Receiver: Audio Circuitry

The demodulated audio signal undergoes complementary signal processing to complete the dynamic range recovery and noise reduction action begun in the transmitter. For conventional compander systems, a 1:2 expansion is applied, followed by a high-frequency de-emphasis. If a multi-band process was used in the transmitter, the received audio is divided into the corresponding bands, each band is expanded, the high frequency band is de-emphasized, and finally the bands are recombined to yield the full-range audio signal.

In the case of a signal-dependent compression system, complementary variable expansion is used followed by high frequency de-emphasis. Again, a precision VCA with a true-rms audio level detector is required.

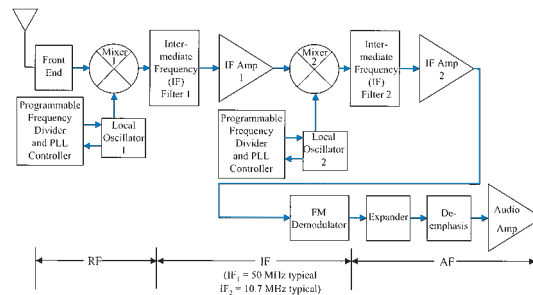

Figure 2-14b: double conversion, frequency-synthesized receiver

As mentioned in the Transmitter description, a hybrid analog receiver may use digital signal processing of the audio signal to complement the processing (analog or digital) used in the transmitter.

Finally, an output amplifier supplies the necessary audio signal characteristics (level and impedance) for connection to an external device such as a mixer input, a recorder, headphones, etc. Typically, better receivers will include a balanced output that can be switched between line level and microphone level. Unbalanced outputs are usually provided as well.

Receiver: Squelch

One additional circuit that is important to proper receiver behavior is called "squelch" or muting. The function of this circuit is to mute or silence the audio output of the receiver in the absence of the desired radio signal. When the desired signal is lost (due to multi-path dropout, excessive distance, loss of power to the transmitter, etc.) the "open" receiver may pick up another signal or background radio "noise." Typically, this is heard as "white" noise and is often much louder than the audio signal from the desired source.

The traditional squelch circuit is an audio switch controlled by the radio signal level using a fixed or manually adjustable threshold (level). (See Figure 2-15.) When the received signal strength falls below this level the output of the receiver is muted. Ideally, the squelch level should be set just above the background radio noise level or at the point where the desired signal is becoming too noisy to be acceptable. Higher settings of squelch level require higher received signal strength to unmute the receiver. Since received signal strength decreases as transmission distance increases, higher squelch settings will decrease the operating range of the system.

One refinement of the standard squelch circuit is referred to as "noise squelch." (See Figure 2-16.) This technique relies on the fact that the audio from undesirable radio noise has a great deal of high frequency energy compared to a typical audio signal. The noise squelch circuit compares the high frequency energy of the received

signal to a reference voltage set by the squelch adjustment. In this system the squelch control essentially determines the "quality" of signal (signal-to-noise ratio) required to unmute the receiver. This allows operation at lower squelch settings with no likelihood of noise if the desired signal is lost.

A further refinement is known as "tone-key" or "tone-code" squelch. It enables the receiver to identify the desired radio signal by means of a supra- or sub-audible tone that is generated in the transmitter and sent along with the normal audio signal. The receiver will unmute only when it picks up a radio signal of adequate strength and also detects the presence of the tone-key. This effectively prevents the possibility of noise from the receiver when the desired transmitter signal is lost, even in the presence of a (non-tone-key) interfering signal at the same frequency.

Turn-on and turn-off delays are incorporated in the transmitter tone-key circuits so that the transmitter power switch operates silently. When the transmitter is switched on, the radio signal is activated immediately but the tone-key is briefly delayed, keeping the receiver muted until the signal is stable. This masks any turn-on noise. When the transmitter is switched off, the tone-key is deactivated instantly, muting the receiver, but actual turn-off of the transmitted signal is delayed slightly. This masks any turn-off noise. As a result, the need for a separate mute switch is eliminated. Finally, the tone-key signal is often used to transmit additional information to the receiver. This may include battery voltage, transmitter audio gain settings, transmitter type, and transmitter power level.

Receiver: Antenna Configuration

Fixed receivers are offered in two basic external configurations: diversity and non-diversity. Non-diversity receivers are equipped with a single antenna while diversity receivers generally have two antennas. Both systems may offer otherwise similar outward features: units may be free standing or rack-mountable; outputs may include balanced/unbalanced microphone or line level as well as headphones; indicators for power and audio/radio signal level may be present; controls for power and audio output level are provided; antenna(s) may be removable or permanently attached. (See Figure 2-17.)

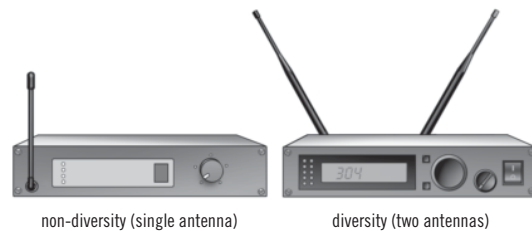

Figure 2-17: examples of receivers

Though diversity receivers tend to include more features than non-diversity types, the choice of diversity vs. non-diversity receiver is usually dictated by performance and reliability considerations. Diversity receivers can significantly improve both qualities by minimizing the effect of variations in radio signal strength in a given reception area due to fading or due to multi-path. Fading is a loss of signal strength at excessive distance or because of shadowing or blocking of the radio wave. Multi-path is a more complex phenomenon but both mechanisms can adversely affect radio reception.

Multipath

A necessary element in the concept of diversity radio reception is the occurrence of "multi-path" effects in radio transmission. In the simplest case, radio waves proceed directly from the transmitting antenna to the receiving antenna in a straight line. The received signal strength is only a function of the transmitter power and the distance between the transmitting and receiving antennas. In practice, this situation could only occur outdoors on level, unobstructed terrain.

In most situations, however, there are objects that attenuate radio waves and objects that reflect them. Since both the transmitting and receiving antennas are essentially omnidirectional, the receiving antenna picks up a varying combination of direct and reflected radio waves. The reflected waves and direct waves travel different distances (paths) to arrive at the receiving antenna, hence the term multi-path. (See Figure 2-18.)

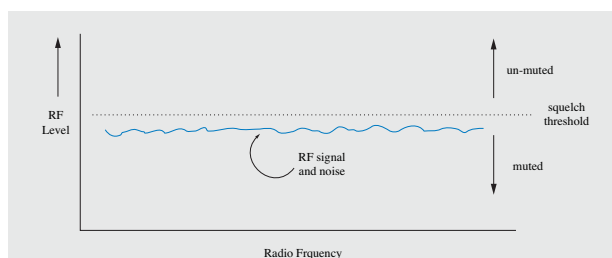

Figure 2-15: threshold squelch

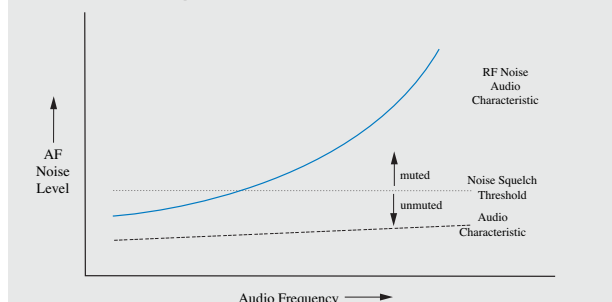

Figure 2-16: noise squelch

Selection and Operation of WIRELESS Microphone Systems

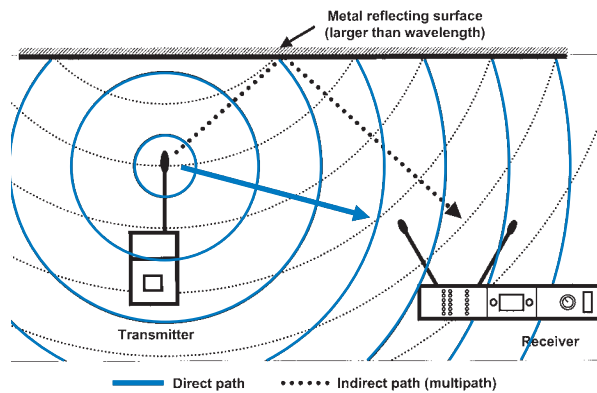

Figure 2-18: multipath

These multiple paths result in differing levels, arrival times and phase relationships between the radio waves. The net received signal strength at any location is the sum of the direct and reflected waves. These waves can reinforce or interfere with each other depending on their relative amplitude and phase. The result is substantial variation in average signal strength throughout an area. This creates the possibility of degradation or loss of the radio signal at certain points in space, even when the transmitter is at a relatively short distance from the receiver. Cancellation of the signal can occur when the direct and indirect waves are similar in amplitude and opposite in phase. (See Figure 2-19.)

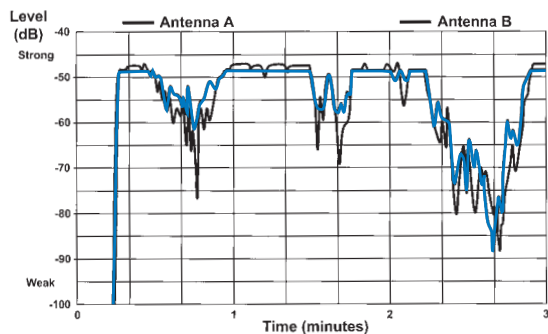

Figure 2-19: signal level at two antennas with multipath

The audible effects of such signal strength variation range from a slight swishing sound ("noise-up"), to severe noises ("hits"), to complete loss of audio ("dropout"). Similar effects are sometimes noted in automobile radio reception in areas with many tall buildings. The "size" of a dropout region is related to wavelength: in the VHF range (long wavelength) dropout areas are larger but farther apart, while in the UHF range (short wavelength) they are smaller but closer together. For this reason, multi-path effects tend to be more severe in the UHF range. These effects are unpredictable, uncomfortable, and ultimately unavoidable with single-antenna (non-diversity) receivers.

Receiver: Diversity Techniques

Diversity refers to the general principle of using multiple (usually two) antennas to take advantage of the very low probability of simultaneous dropouts at two different antenna locations. "Different" means that the signals are statistically independent at each location. This is also sometimes called "space diversity," referring to the space between the antennas.

For radio waves, this "de-correlation" is a function of wavelength: a separation of one wavelength results in nearly complete de-correlation. In most cases, at least one-quarter wavelength separation between antennas is necessary for significant diversity effect: about 40 cm for VHF systems and about 10 cm for UHF systems. Some increased benefit may be had by greater separation, up to one wavelength. Spacing beyond one wavelength does not significantly improve diversity performance, but large or unusually shaped areas may be covered with greater antenna separation.

There are a number of diversity techniques that have had some degree of success. The term "true" diversity has come to imply those systems which have two receiver sections, but technically, any system which samples the radio field at two (or more) different locations, and can "intelligently" select or combine the resulting signals is a true diversity system.

The simplest technique, called "passive antenna combining" utilizes a single receiver with a passive combination of two or three antennas. Antennas combined in this manner create an "array," which is essentially a single antenna with fixed directional characteristic. In its most effective form (three antennas, each at right angles to the other two) it can avoid complete dropouts, but with a reduction of maximum range. This is because the array output will almost always be less than the output of a single antenna at the optimum location. If only two antennas are used, dropouts can still occur in the event of an out-of-phase condition between them. Cost is relatively low but setup of multiple antennas can be somewhat cumbersome. This is not a "true" diversity design. (See Figure 2-20.)

A true diversity variation of this technique is "antenna phase diversity." It also employs two antennas and a single receiver but provides an active combining circuit for the two antennas. This circuit can switch the phase of one antenna relative to the other, eliminating the possibility of phase cancellation between them. However, switching noise is possible as well as other audible effects if switching is incorrect. Range is sometimes greater with favorable antenna combinations. Cost is relatively low. Setup requires somewhat greater antenna spacing for best results. (See Figure 2-21.)

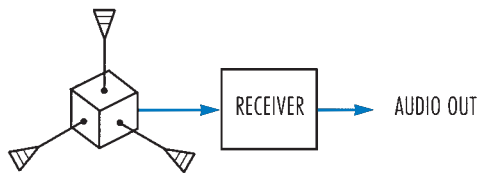

Figure 2-20: passive antenna combining

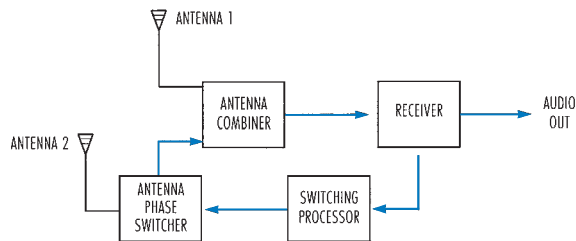

Figure 2-21: antenna phase switching

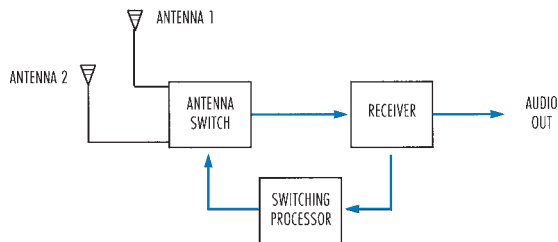

Figure 2-22: antenna switching

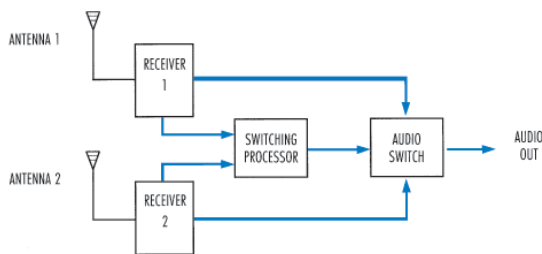

Figure 2-23: receiver switching

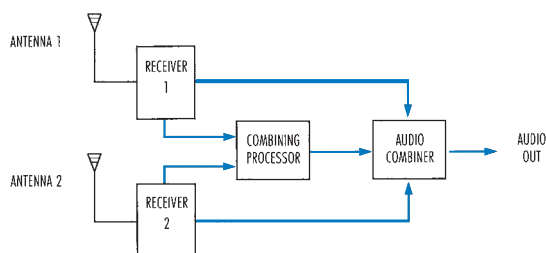

Figure 2-24: receiver combining

The next variation, "antenna switching diversity," again consists of a single receiver with two antennas. The receiver includes circuitry that selects the antenna with the better signal according to an evaluation of the radio signal. Switching noise is possible but this system avoids the possibility of phase cancellation between antennas because the antennas are never combined. Range is the same as for a single antenna system. Cost is relatively low and setup is convenient. (See Figure 2-22.)

In both of these active antenna diversity approaches, the switching decision is based on the received signal quality of a single receiver section. When the signal quality falls below some preset threshold, switching occurs immediately. If the new antenna (or antenna combination) doesn't improve the reception, the receiver must switch back to the original state. The lack of "predictive" ability often causes unnecessary switching, increasing the chance of noise. The switching speed is also critical: too fast and audible noise occurs, too slow and a dropout may occur.

A recent antenna switching method offers predictive diversity capability using a microcontroller to optimize switching characteristics. A running average signal level and a maximum signal level are calculated by analyzing the change in signal level over time. Comparing the current average signal level to the most recent maximum signal level determines the switch action, based on typical dropout characteristics. Small declines at high signal levels indicate impending dropout, causing a switch to occur. At moderate signal levels, larger decreases are allowed before switching. At very low signal levels switching is curtailed to avoid unnecessary noise. Of course, if the signal level is increasing, no switching occurs. The onset of dropout can be more accurately recognized and countered, while eliminating switching when there is little likelihood for improvement.

"Receiver switching diversity" is a widely used diversity system. It consists of two complete receiver sections, each with its own associated antenna, and circuitry that selects the audio from the receiver that has the better signal. Switching noise is possible but when properly designed these systems can have very good dropout protection with little chance of other audible effects due to incorrect selection. This is because the system compares the signal condition at each receiver output before audio switching occurs. Range is the same as with single antenna systems. Cost is higher, but setup is convenient. (See Figure 2-23.)

"Ratio combining diversity" also uses two complete receiver sections with associated antennas. This design takes advantage of the fact that, most of the time, the signal at both antennas is useable. The diversity circuitry combines the outputs of the two receiver sections by proportionally mixing them rather than switching between them. At any given moment, the combination is proportional to the signal

Selection and Operation of

WIRELESS

Microphone Systems

quality of each receiver. The output will usually consist of a mix of the two audio sections. In the case of loss of reception at one antenna, the output is chosen from the other section. Excellent dropout protection is obtained with no possibility of switching noise since the diversity circuit is essentially an intelligent panpot, not a switch. (See Figure 2-24.) Signal-to-noise is improved by up to 3 dB. Range can be greater than with single antenna systems. Cost is somewhat higher, setup is convenient.

A properly implemented diversity system can yield measurable improvements in reliability, range, and signal-to-noise ratio. Although a comparable non-diversity system will perform adequately most of the time in typical setups, the extra insurance of a diversity system is worthwhile. This is particularly true if the RF environment is severe (multipath), troubleshooting time is minimal (no rehearsal), or dropout-free performance is required (ideally always). The price difference is small enough that diversity receivers are typically chosen in all but the most budget-conscious applications.

An additional method for improving signal reliability in the presence of interference is called "Frequency Diversity". This technique relies on the low likelihood of simultaneous interference on two different radio frequencies. To set up a frequency diversity system requires two transmitters, each set to a different frequency, and two matching receiver channels. The two received signals are connected to an audio mixer on two separate channels. If the signal from either transmitter is interrupted, the audio engineer can continue with the remaining signal.

Presently, this is practical only by using two bodypack transmitters on a single individual, typically with lavalier or headworn microphones. They may be connected to a single microphone or possibly two closely-spaced microphones. Frequency diversity is generally reserved for the primary user in critical situations where the cost of "double-packing" is justified.

However, handheld transmitters are now available that can transmit simultaneously on two different frequencies. In addition, the matching receivers can automatically transition between the two signals when interference occurs so that only a single mixer channel is required and no manual intervention is necessary to maintain signal continuity.

Antennas

In addition to the circuitry contained inside transmitters and receivers, one critical circuitry element is often located outside the unit: the antenna. An antenna is electrically "resonant" (tuned) at a particular frequency or range of frequencies. Since frequency is inversely related to wavelength (via the Wave Equation), the size of the antenna is directly related to the corresponding radio wavelength(s). Lower radio frequencies require larger antennas, while higher frequencies use smaller antennas. Another characteristic of antennas is their relative efficiency at converting electrical power into radiated power and vice versa. An increase of 6 dB in radiated power, or an increase of 6 dB in received signal strength can correspond to a 50% increase in range. Likewise, a loss of 6 dB in signal may result in 50% decrease in range. Finally, antennas are said to be "reciprocal". That is, they can generally operate in a transmitting mode or in a receiving mode with exactly the same characteristics. The exception is an "active" (amplified) antenna which can be used only in a receiving mode due to its built-in receive-only amplifier.

The function of an antenna is to act as the interface between the internal circuitry of the transmitter (or receiver) and the external radio signal. In the case of the transmitter, it must radiate the desired signal as efficiently as possible, that is, at the desired strength and in the desired direction. Since the output power of most transmitters is limited by regulatory agencies to some maximum level, and since battery life is a function of power output, antenna efficiency is critical. At the same time, size and portability of transmitters is usually very important. This results in only a few suitable designs for transmitter antennas. (See Figure 2-25.)

The smallest simple antenna that is consistent with reasonable transmitter output is an antenna that is physically (and electrically) one quarter as long as the wavelength of the radio wave frequency being transmitted. This is called a

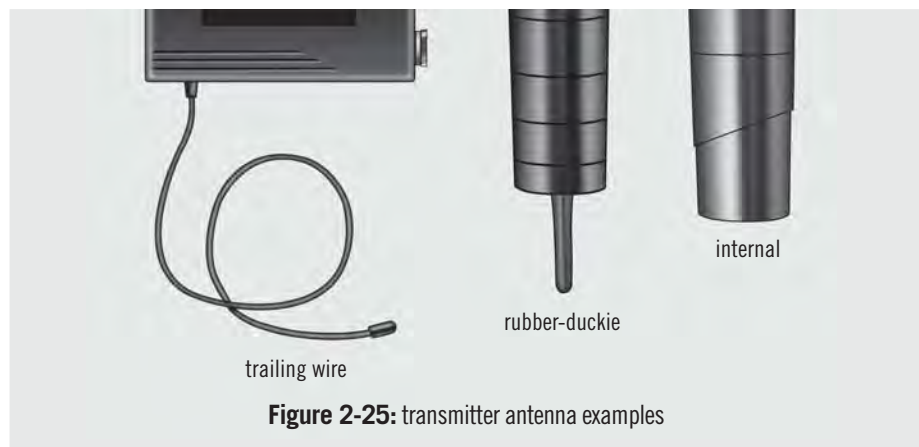

Figure 2-25: transmitter antenna examples

"1/4 wave" antenna. It takes different forms depending on the type of transmitter being used. For some bodypack transmitters, the antenna is a trailing wire cut to an appropriate length. In other designs the cable that attaches the microphone to the transmitter may be used as the antenna. In either case, the antenna must be allowed to extend to its proper length for maximum efficiency. The effective bandwidth of this antenna type is great enough that only about three different lengths are required to cover the high-band VHF range. For transmitter applications requiring even smaller antenna size a short "rubber duckie" antenna is sometimes used. This type is still (electrically) a 1/4 wave antenna, but it is wound in a helical coil to yield a shorter package. There is some loss in efficiency due to the smaller "aperture" or physical length. In addition, these antennas have a narrower bandwidth. This may require up to six different lengths to cover the entire high-band VHF range for example.

Handheld transmitters generally conceal the antenna inside the body of the unit, or use the outer metal parts of the case as the antenna. In either design, the antenna is rarely a true 1/4 wave long. This results in somewhat less radiated power for a handheld transmitter with an internal antenna than a comparable bodypack design with an external antenna. However, antenna output is somewhat reduced when placed close to the body of the user. Since the antenna of a hand-held transmitter is usually at some distance from the body, though, the practical difference may be small. Plug-on type transmitters normally use the microphone body and the transmitter case itself as the antenna, though some manufacturers models have used an external antenna. In practice the typical VHF transmitter antenna is less than 10% efficient. UHF types may be significantly better because the shorter wavelength of these frequencies is more consistent with the requirement for a small antenna.

In all of these designs, the radio wave pattern emitted by the antenna is omnidirectional in the plane perpendicular to the axis of the antenna. For a vertically oriented antenna the radiation pattern is omnidirectional in the horizontal plane, which is the typical case for a trailing wire antenna. There is very little output along the axis of the antenna. A three-dimensional representation of the field strength from a vertical antenna would resemble a horizontal doughnut shape with the antenna passing through the center of the hole. (See Figure 2-26.)

Recall that a radio wave has both an electric field component and a magnetic field component. A vertically oriented transmitter antenna radiates an electric field component that is also vertical (while the magnetic field component is horizontal). This is said to be a "vertically polarized" wave. Horizontal orientation of the antenna produces a "horizontally polarized" wave.

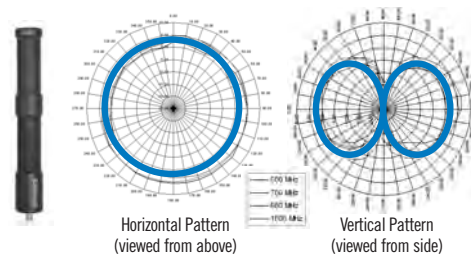

Figure 2-26: wideband omnidirectional antenna

In receiver applications, the antenna must pick up the desired radio signal as efficiently as possible. Since the strength of the received signal is always far less than that of the transmitted signal this requires that the antenna be very sensitive to the desired signal and in the desired direction. However, since the size and location of the receiver are less restrictive, and since directional pickup may be useful, a much greater selection of antenna types is generally available for receivers.

Again, the minimum size for adequate reception is 1/4 wavelength. A whip or telescoping antenna of this size is supplied with most receivers, and it too is omnidirectional in the horizontal plane when it is vertically oriented. An important consideration in the performance of a 1/4 wave receiving antenna is that its efficiency depends to some extent on the presence of a "ground plane," that is, a metal surface at least 1/4 wave long in one or both dimensions and electrically connected to the receiver ground at the base of the antenna. Typically, the receiver chassis or receiver PC board to which the antenna is attached acts as a sufficient ground plane. (See Figure 2-27.)

If more sensitivity is desired, or if it is necessary to mount an omnidirectional antenna remotely from the receiver, 1/2 wave or 5/8 wave antennas are often used. These antennas have a theoretical "gain" (increase of sensitivity) up to 3 dB greater than the 1/4 wave antenna in some configurations. This can translate into increased range for the system. However, the 5/8 wave antenna, like the 1/4 wave type, only achieves its performance with an appropriate ground plane. Without a ground plane unpredictable effects may occur resulting in asymmetric pickup patterns and potential signal loss due to the non-ideal cable/antenna interface. A properly designed 1/2 wave antenna does not require a ground plane, allowing it to



Figure 2-27: 1/4 wave and 1/2 wave antennas UHF range

Selection and Operation of

WIRELESS

Microphone Systems

be remotely mounted with relative ease. It can also maintain proper impedance at the cable/antenna interface or can be directly attached to a receiver or antenna distribution system. In addition, it is resistant to the effects of electrical noise that might otherwise be picked up at the interface.

When antenna size is an issue, such as for portable receivers, the previously mentioned 1/4 wave rubber duckie is an option. UHF designs can use 1/4 wave rubber duckies because of the shorter wavelengths. Another relatively small size remote antenna can be found in the form of a 1/4 wave antenna with an attached array of radial elements that function as an integral ground plane. Both of these types are omnidirectional in the horizontal plane when mounted vertically. For maximum efficiency, receiving antennas should be oriented in the same direction as the transmitting antenna. In the same way that a transmitter antenna produces a radio wave that is "polarized" in the direction of its orientation, a receiver antenna is most sensitive to radio waves that are polarized in its direction of orientation. For example, the receiving antenna should be vertical if the transmitting antenna is vertical. If the orientation of the transmitting antenna is unpredictable (ie. handheld use), or if the polarization of the received wave is unknown (due to multipath reflections) a diversity receiver can have even greater benefit. In this case it is often effective to orient the two receiving antennas at different angles, up to perhaps 45 degrees from vertical.

Unidirectional antennas are also available for wireless microphone systems. These designs are comprised of a horizontal boom with multiple transverse elements and are of the same general type as long range antennas for television reception. They can achieve high gain (up to 10 dB compared to the 1/2 wave type) in one direction and can also reject interfering sources coming from other directions by as much as 30 dB. (See Figure 2-28.)

Two common types are the Yagi and the log-periodic. The Yagi consists of a dipole element and one or more additional elements: those located at the rear of the boom are larger than the dipole element and reflect the signal

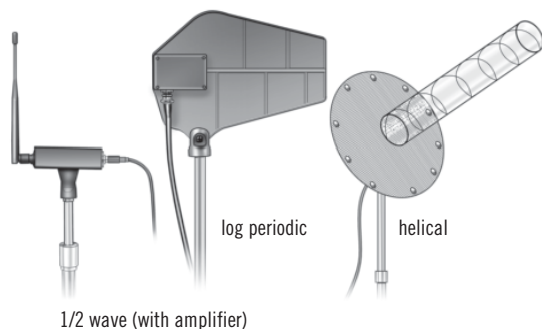

Figure 2-28: examples of remote receiver antennas

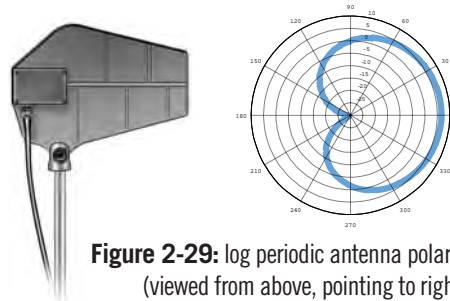

Figure 2-29: log periodic antenna polar pattern (viewed from above, pointing to right)

back to the dipole while those located at the front are smaller than the dipole and act to direct the signal on to the dipole. The Yagi has excellent directivity but has a fairly narrow bandwidth and is usually tuned to cover just one TV channel (6 MHz). The log-periodic achieves greater bandwidth than the Yagi by using multiple dipole elements in its array. The size and spacing between the dipoles varies in a logarithmic progression so that at any given frequency one or more dipoles are active while the others are functioning as reflecting or directing elements, depending on their size and location relative to the active element(s). The longer the boom and the greater the number of elements the greater is the bandwidth and the directivity. A typical log-periodic antenna has 6-8 dB of forward gain and a coverage angle of about 120 degrees. (See Figure 2-29.)

The helical antenna is a special type of directional antenna. It is a broadband antenna with up to 12 dB of forward gain but with a coverage angle of only about 60 degrees. However, the helical antenna does not have a preferred polarization angle. That is, when used as a receive antenna it is equally sensitive to incoming signals polarized at any angle. Likewise, when used as a transmit antenna, the radiated signal can be picked up equally well by receive antennas oriented at any angle. This makes the helical antenna particularly useful when a high-gain transmit antenna is needed for use with non-diversity receivers such as in-ear monitor packs.

Although these directional antennas are somewhat large (3-5 ft. wide for VHF) and may be mechanically cumbersome to mount, they can provide increased range and greater rejection of interfering sources for certain applications. It should also be noted here that these antennas should be oriented with the transverse elements in the vertical direction rather than the horizontal direction (as would be used for television reception), again because the transmitting antennas are usually also vertical.

Antenna Cable

An important but often overlooked component of many wireless microphone systems is the antenna cable. Applications in which the receiver is located away from the transmitter vicinity and/or within metal racks will require the use of remote antennas and connecting cables. Compared

to audio frequency signals, the nature of radio frequency signal propagation in cables is such that significant losses can occur in relatively short lengths of cable. The loss is a function of the cable type and the frequency of the signal. Figures 2-30 and 2-31 give some approximate losses for various commonly used antenna cables at different radio frequencies. It may be noted from this chart that these cables have a "characteristic" impedance, typically 50 ohms. Ideally, for minimum signal loss in antenna systems, all components should have the same impedance: that is the antennas, cables, connectors and the inputs of the receivers. In practice, the actual losses due to impedance mismatches in wireless receiver antenna systems are negligible compared to the losses due to antenna cable length. For this reason, it may be acceptable to substitute certain 75 ohm cable types when the specified loss-per-unit-length at a given frequency is comparable to the corresponding 50 ohm type. For example, a quality RG-6 (75 ohm) cable may be substituted for a similar RG-8/RG-213 (50 ohm). Note that 75 ohm connectors are required for 75 ohm cable, but 75 ohm BNC connectors will mate with 50 ohm BNC connectors.

Obviously, the benefits of even a high gain antenna can be quickly lost using the wrong cable or too long a cable. In general, antenna cable lengths should be kept as short as possible. Antenna amplifiers can be used to compensate for losses in long cable runs. (See Figure 2-35.)

In addition, the construction of the cable should be considered: coaxial cables with a solid center conductor and stiff insulator/shield are most suitable for permanent installation, while cables with stranded conductors and flexible insulator/ shield should be used for portable applications which require repeated setups. Finally, the number of connections in the antenna signal path should be kept to a minimum.

Antenna Distribution

The last component found in larger wireless receiver systems is some form of antenna signal distribution. It is often desirable to reduce the total number of antennas in multiple systems by distributing the signal from one set of

antennas to several receivers. This is usually done to simplify system setup, but can also improve performance by reducing certain types of interference as will be seen later. There are two general types of antenna distribution available: passive and active. Passive antenna splitting is accomplished with simple in-line devices that provide RF impedance matching for minimum loss. Still, a single passive split results in about a 3 dB loss, which may translate into some loss of range. (See Figure 2-33.) Multiple passive splits are impractical due to excessive signal loss.

To allow coupling of antenna signals to more receivers and to overcome the loss of passive splitters, active antenna distribution amplifiers are used. These are also known as "active antenna splitters" or "antenna multi-couplers." These devices provide enough amplification to make up for splitter loss, and usually operate at "unity" gain overall, that is, no net amplification occurs. Though a multi-coupler is generally a separate accessory, some receiver designs are equipped with internal antenna distribution when multiple receiver sections are incorporated in the same chassis such as modular or card-cage systems.

Stand-alone active antenna splitters can typically feed up to four receivers from one set of antennas. (See Figure 2-34a.) If more receivers are required, the outputs of one distribution amplifier can feed the inputs of a second level set of distribution amplifiers. (See Figure 2-34b.) Each of these can then feed several receivers. Two or possibly three levels of active splitters is the maximum recommended, due to the potential for increased RF distortion and interference.

Certain receiver designs incorporate active antenna "cascade" outputs. Since these outputs are unity gain, it is possible to cascade the antenna signals from one receiver to the next, up to as many as ten units. A limitation of the typical "daisy chain" scheme is that all receivers must be in the same frequency band. Another consideration is that in the event of power loss or antenna connection loss to a particular receiver, all subsequent receivers in the cascade will lose antenna signal. Nevertheless, active cascade ports can simplify hookup and reduce the requirement for stand-alone active splitters.

Cable Type	Impedance	Construction	NOMINAL ATTENUATION		
			MHz	dB/100 ft	dB/100m
RG58C/U	50 Ohm Impedance	<ul style="list-style-type: none"> Center Conductor: 20 (19x33) AWG tinned copper Shielding: Tinned copper braid (95% coverage) Insulation: Polyethylene Jacket: Black PVC Operating Temperature: -40°C to +85°C 	50	3.3	10.8
			100	4.9	16.1
			200	7.1	23.9
			400	11.0	36.1
			1000	20.0	63.0
RG213/U	50 Ohm Impedance	<ul style="list-style-type: none"> Center Conductor: 13 (12x21) AWG bare copper Shielding: Bare copper braid (97% coverage) Insulation: Polyethylene Jacket: Black PVC Operating Temperature: -40°C to +85°C 	30	1.5	4.9
			100	2.7	8.4
			200	3.9	12.0
			400	4.8	15.7
			1000	8.2	26.0

Figure 2-30: comparison of coaxial cable types

Typical Loss for 50 Ohm Cable

Type Of Cable	Loss @ 200MHz (100 ft)	Loss @ 800MHz (100 ft)
RG58C/U (Belden 8262)	7.5 dB	18.5 dB
RG8X/U (Belden 9258)	4.5dB	12 dB
RG213/U (Belden 8267)	2.7 dB	7.1 dB
RG8/U (Belden 9913)	1.8 dB	3.9 dB

Figure 2-31: coaxial antenna cable loss at VHF and UHF frequencies

Selection and Operation of WIRELESS Microphone Systems

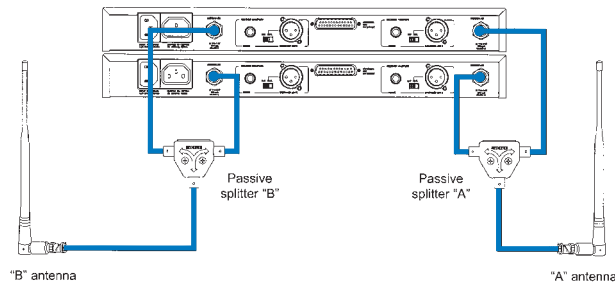

Figure 2-33: passive antenna distribution

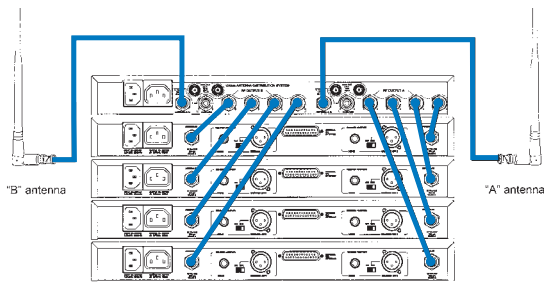

Figure 2-34a: active antenna distribution (one level)

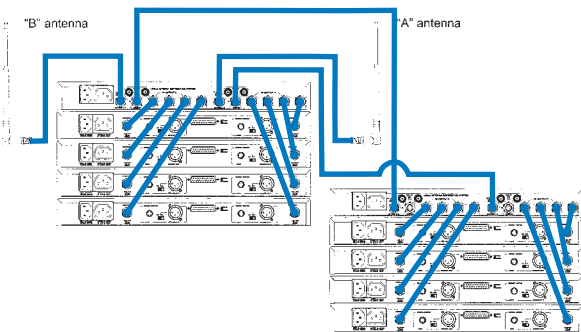

Figure 2-34b: active antenna distribution (two level)

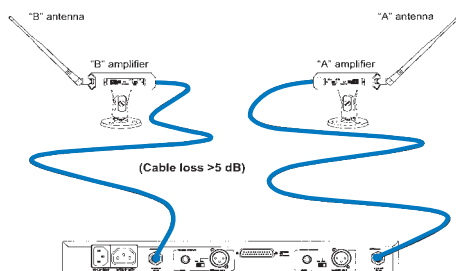

Figure 2-35: antenna amplifiers

Large Room/Multi-Room Applications

Sometimes it is desired to use a single wireless transmitter throughout a very large space or in multiple rooms. It is difficult to get reliable reception from transmitters in distant rooms or in extremely large rooms, especially if there are many obstructions or strong RF interference. A centrally located receiver antenna may improve the situation. Line-of-sight transmitter to receiver placement is always the preferred setup.

If a diversity receiver with detachable antennas is used the two antennas may be located in different rooms, though this essentially reduces the receiver mode to two non-diversity sections. If diversity reception is to be maintained two antennas may be located in each room with the use of an antenna combiner. The "A" antenna in one room is combined with the "A" antenna in the other room using an antenna combiner. The "B" antennas are similarly connected and the "A" and "B" combiner outputs are fed to the receiver "A" and "B" antenna inputs. (See Figure 2-32.)

It is also possible to use multiple receivers and antennas tuned to the frequency of a single transmitter. The audio outputs of the receivers can then be combined in a mixer to allow continuous pickup of the signal from multiple locations. However, some type of audio level control must be employed since the audio level of such a system will increase by 3dB each time the number of active receivers doubles. That is, if the transmitter is picked up by two receivers at the same time the overall audio level will be 3dB louder than when picked up by only one receiver. Automatic mixers can control this effect.

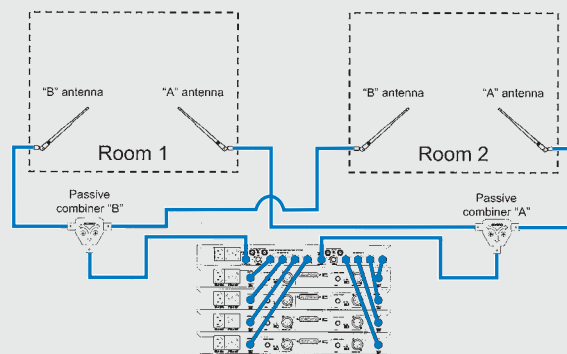

Figure 2-32: multi-room antenna distribution

CHAPTER THREE

WIRELESS SYSTEM OPERATION

Frequency Bands For Wireless Systems

Existing wireless microphone systems transmit and receive on a specific radio frequency, called the operating frequency. Individual radio frequencies are found in frequency "bands" which are specific ranges of frequencies.

Use of radio frequencies in the United States is regulated by the FCC (Federal Communication Commission). The FCC has designated certain bands of frequencies and certain frequencies in those bands for use by wireless microphones, as well as by other services. In the US, the frequencies used for wireless audio systems may be grouped into four general bands or ranges: low-band VHF (49-108 MHz), high-band VHF (169-216 MHz), low-band UHF (450-698 MHz) and high-band UHF (900-952 MHz). VHF stands for "Very High Frequency," UHF stands for "Ultra High Frequency." (See Figure 3-1.)

The FCC further determines who can operate in each band and who has priority if more than one user is operating. "Primary" users include licensed broadcasters (radio and television) and commercial communications services (2-way radio, pagers, and cellular telephones). Wireless microphone operators are always considered to be "secondary" users. In general, priority is given to primary users: secondary users may not interfere with primary users, and secondary users may be subject to interference from primary users.

On the subject of licensing, it should be noted that while manufacturers must be licensed by the FCC to sell wireless equipment, it is the responsibility of the operator to observe FCC regulations regarding their actual use.

We will briefly describe each band and its advantages and disadvantages for wireless microphone system operation, based on the designated users of the band, the physical characteristics of the band, and the regulatory limitations of the band.

The VHF Band

At the beginning of the low-band VHF range is the 49 MHz region, used not only by wireless microphones but also by cordless telephones, walkie-talkies, and radio controlled toys. 54-72 MHz is occupied by VHF television channels 2-4. The 72 MHz area is used by "assistive listening" type wireless microphone systems (ALS). 76-88 MHz is assigned to VHF television channels 5 and 6. At the top, 88-108 MHz is the commercial FM radio broadcast band. (See Figure 3-2.) All of these regions have been used at one time or another for wireless microphone systems. Allowable deviation limits (typically up to 15KHz) can accommodate high-fidelity audio (the same as for FM broadcast). The propagation of these waves through the air is very good, as is their ability to pass through many non-metallic substances (a result of their relatively long wavelength). The most attractive feature of operation in this band was low equipment cost.

Except for assistive listening systems, however, low-band VHF is not recommended for serious applications. Due to the large number of primary and secondary users, and high levels of general radio frequency (RF) "noise," this band is prone to interference from many sources. Transmitter power is limited to less than 50 mW (except in the 72-76 MHz range where up to 1 watt is allowed for assistive listening systems). Finally, the minimum proper antenna size for units in this range can be over one meter long (one quarter of a five meter wave), which can severely limit portability and/or efficiency.

Next is the high-band VHF range, historically used for professional applications, in which quality systems were available at a variety of prices. In the US, the high-band

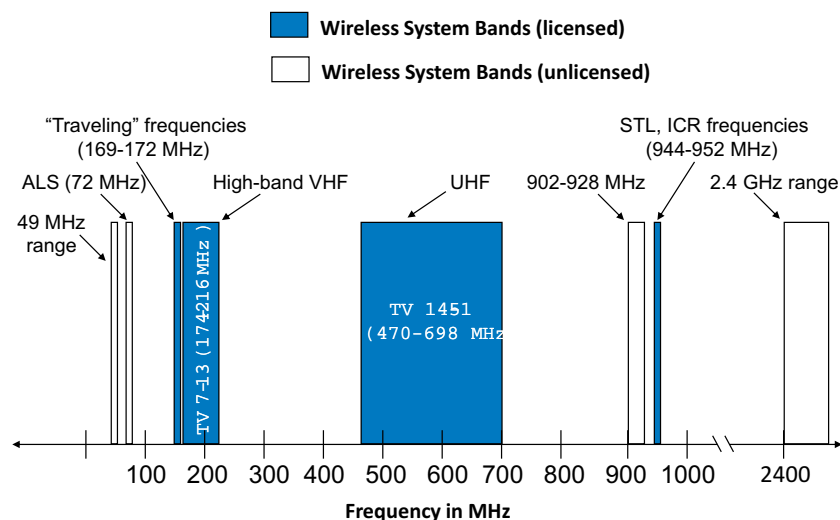

Figure 3-1: wireless frequency bands in the United States

Selection and Operation of WIRELESS Microphone Systems

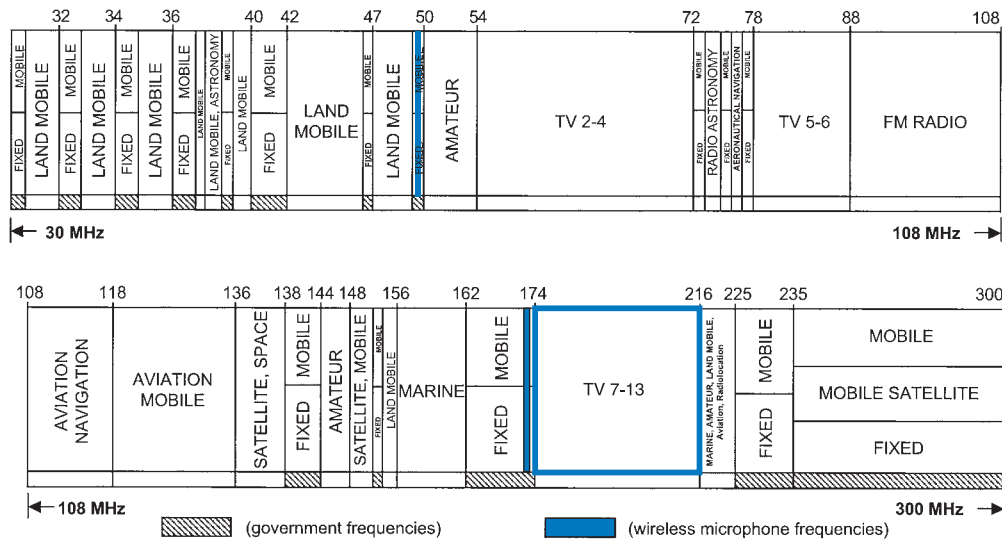

Figure 3-2: VHF allocations in the United States (30-300 MHz)

VHF range is divided into two bands, which are available to wireless microphone users. The first of these, from 169-172 MHz, includes eight specific frequencies designated by the FCC (Part 90.263b or just "Part 90") for wireless microphone use by general business. These frequencies are often referred to as "travelling frequencies," because they can (theoretically) be used throughout the US without concern for interference from broadcast television. Legal limits of deviation (± 12 KHz) allow high quality audio transmission. Once again, power is limited to 50 mw. Propagation characteristics are good, and antenna length is more manageable at about one-half meter for a quarter-wave type.

Unfortunately, the primary users in this band include many business band and government operations such as digital paging services, forestry, hydro-electric power stations, and the Coast Guard. Since the secondary user category is not restrictive, the potential for interference from both primary and other secondary users is always present. Also, general RF noise is still fairly strong in this band. In addition, due to the limitation of available frequency bandwidth, and the spacing of the prescribed eight frequencies, it is only feasible to operate, at most, two or three units simultaneously on travelling frequencies. Finally, these frequencies are not generally legal outside of the US and Canada.

The larger part of the high-band VHF region is 174-216 MHz. This band is designated by the FCC for licensed use by broadcasters and film/video producers, as well as unlicensed use by many secondary users. The primary

users of this band are VHF television channels 7-13. Once again, high quality audio is possible within legal deviation limits (± 15 kHz). The 50 mw power restriction is the same as for low-band, propagation losses are still minimal, and acceptable quarter-wave antenna sizes range down to less than one-half meter.

The possibility of interference from other secondary users and general RF noise exists, but it is much less likely than for low-band frequencies. In addition, although this range includes powerful primary users (television channels 7-13), there are ample frequencies available (locally unused television channels) in almost any part of the US.

Licensing: The FCC has established new licensing rules for wireless audio system users in the VHF and UHF television bands. It is no longer necessary for these systems to be licensed by the user if the transmit power is limited to 50mW or less. Systems used in this way are now classified as "unlicensed secondary users". As such, they must still avoid interfering with the primary users in the band (broadcast television) as well as with licensed secondary users. The devices themselves must still be type-approved by the FCC. Presently, the class of secondary wireless users that may qualify for an FCC license is limited mainly to broadcasters and motion picture/video production businesses.

The UHF Band

The low-band UHF range of frequencies may be considered as two overlapping bands: low (450-512 MHz) and high (470-806 MHz). The primary users of these bands are business services such as land mobile radio and pagers (450-512 MHz), public safety (470-512 MHz), and UHF television channels 14-51 (470-698 MHz). As in the high-band VHF region, unused television channels are available for wireless microphones and other wireless audio devices. Most cities have a significant number of television stations and the largest cities may also have public safety operations. Though RF noise is lower in the UHF band, and there are usually sufficient unused television channels presently, this spectrum is becoming increasingly crowded.

Like high-band VHF, users may be licensed or unlicensed in the UHF band. The required minimum quarter-wave antenna size for UHF radio waves is 9-16 cm (only one-quarter to one-third that for VHF). Equipment is available at a wide range of prices and nearly all are frequency-agile, diversity systems. Very high quality audio can now be achieved as well as a large number of simultaneous systems.

The high-band UHF range (900 MHz-1GHz) includes studio-to-transmitter links (STL 944-952 MHz), other primary users, and a host of secondary users. (See Figure 3-3.) This band offers additional channels and potentially less interference from RF noise, as well as antenna lengths of less than 9 cm. Other operating characteristics are similar to low-band UHF. However, secondary users are allowed to

operate without licensing in much of this range. One such range is 902-928 MHz, a multi-user band that became popular for consumer products such as cordless telephones. Many of these products have moved to the "DECT" band (1920-1930 MHz) reducing congestion in 900 MHz band. There are now several high quality wireless microphone systems that operate in this range, most of them fully digital. While not completely immune to interference from other users within that band, they do offer performance comparable to analog systems in the standard UHF band. The primary limitation for most of this 900 MHz equipment is that a maximum of about five systems may be operated simultaneously in this range due to occupied bandwidth requirements.

Recently, the 2.4 GHz band has attracted some interest for wireless microphone use. Potential advantages of this band are: very short antennas (less than 4 cm.), no high power primary users, international availability (almost), no bandwidth/modulation scheme limits, and no license requirement. Unfortunately, these same features have already attracted a considerable number of users: cordless telephones and short-to-medium range wireless network applications such as "Bluetooth" and "Wi-Fi." Add to this the existing base of 2.4 GHz users that includes the ISM (Industrial, Scientific, and Medical) band as well as the lowly microwave oven and it would appear that this band may be subject to the same fate as its other unlicensed predecessors. However, many of the devices in this band use a "spread-spectrum" modulation scheme, which

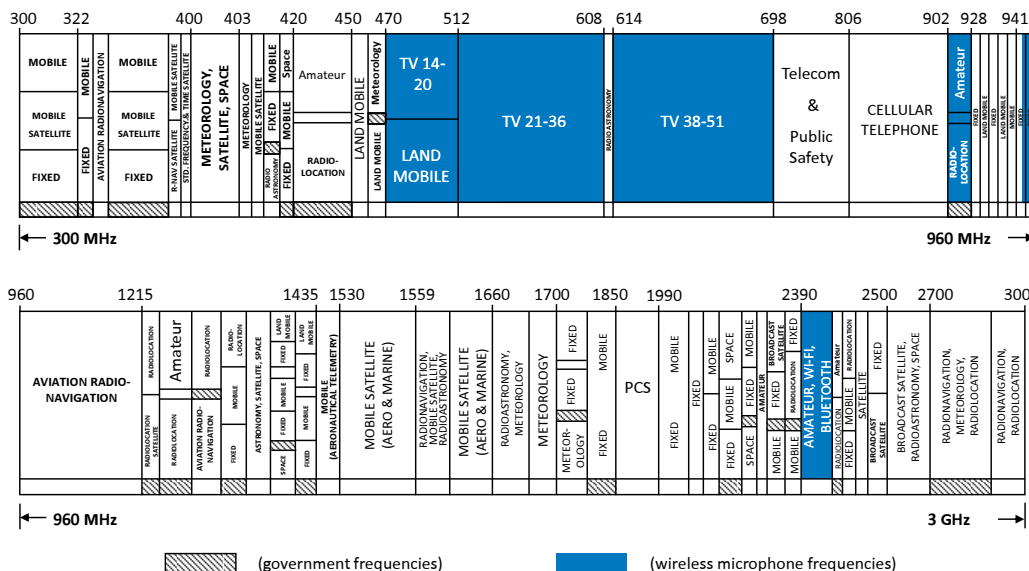

Figure 3-3: UHF allocations in the United States (300 MHz - 3GHz)

reduces mutual interference to some extent. Using similar schemes, several manufacturers have developed digital wireless audio systems that can successfully operate in the presence of other existing 2.4GHz equipment.

Finally, it should be kept in mind that the allocation of these bands is always subject to change as demand for spectrum increases. In the US, for example, proposals to designate unused VHF TV channels in major urban areas for use by land-mobile services are being considered. The 700 MHz band (actually 698-806 MHz) is now occupied by telecommunications services and public safety. As always, manufacturers and users must continue to evaluate these developments for their impact on wireless system operation.

Why UHF?

Though the VHF range offered the benefit of good propagation due to longer wavelengths, several features of the UHF range eventually dominated the interest of most manufacturers and users. A combination of larger frequency range (222 MHz UHF vs. 42 MHz VHF), smaller antennas (UHF less than half the size of VHF), and dramatic radio circuitry advances have all but eliminated VHF systems from the current landscape. Present UHF systems offer much greater performance capabilities than historical VHF systems and at comparable or even lower cost.

Although the UHF television band has been reduced by regulatory agencies, it remains the largest contiguous block of radio spectrum in most countries, particularly in the US. In response, UHF wireless systems have become considerably more efficient in bandwidth use and continue to offer large numbers of simultaneous systems at reasonable cost. For that reason, the UHF band is expected to remain the primary range for professional wireless audio use.

Frequency Selection

Selecting the operating frequency of a wireless audio system is a two-step process: first, choose an appropriate radio frequency band; second, choose the appropriate operating frequency (or frequencies) within that band. As indicated above, there is a finite number of wireless microphone systems that may be used simultaneously in any one frequency range. The reasons for this limitation are several and they fall under the general topic of frequency coordination or "compatibility." We will define these factors and examine each in terms of origin, effects, and relative importance to total system compatibility. In the first section we will consider only interactions that may occur between the individual wireless microphone systems themselves. Outside (non-system) interactions will be discussed in the second section.

At this point it should be stated that frequency coordination is a process that must take into account various factors including the physical (limitations), the mathematical (calculations) and the political (regulations). It is not necessary for most users to go through the details of this process. Wireless manufacturers provide this service through pre-selected frequency groups and can also offer assistance in complex applications using proprietary computer programs. What follows here is an introduction to the process for the interested user.

System Compatibility

The two main areas of concern are: interaction between transmitters and receivers related to their operating frequencies, and interactions between transmitters and receivers related to their internal frequencies. The first class of interactions is the more important one and may occur in any group of wireless microphone systems. It is also the one more cumbersome to calculate. The second class of interactions is less problematic and is also relatively easy to predict. However, it is determined by specific system characteristics.

Operating Frequency Interactions: Intermodulation

A single wireless microphone system can theoretically be used on any open operating frequency. When a second system is added it must be on a different operating frequency in order to be used at the same time as the first. This limitation arises from the nature of radio receivers: they cannot properly demodulate more than one signal on the same frequency. In other words, it is not possible for a receiver to "mix" the signals from multiple transmitters. If one signal is substantially stronger than the others it will "capture" the receiver and block out the other signals. If the signals are of comparable strength none of them will be received clearly.

The effect of this is often heard in automobile radios when travelling out of range of one station and into the range of another station at the same frequency. The receiver will switch back and forth between the two stations as their relative signal strength changes, often with considerable noise and distortion. The result is that neither station is listenable when the signals are nearly equal.

If the wireless microphone systems must be on different frequencies, how "different" should they be? The limiting characteristic of the receiver in this regard is its "selectivity" or its ability to differentiate between adjacent frequencies. The greater the selectivity the closer together the operating frequencies can be. The recommended minimum frequency difference ranges from 300kHz to 1.5 MHz, depending on receiver selectivity.

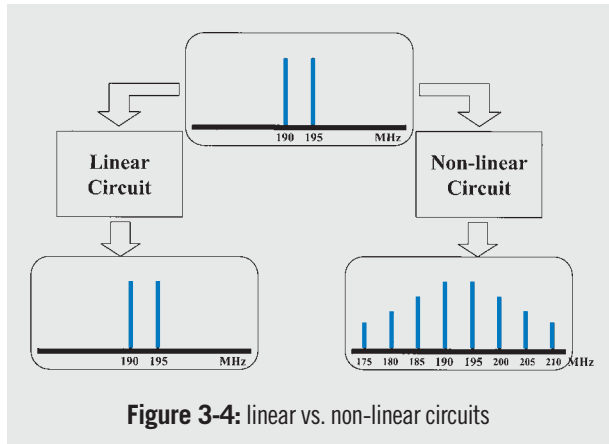

Figure 3-4: linear vs. non-linear circuits

When a third system is added to the group it must be at least the recommended frequency difference from each of the existing systems. However, it is now necessary to consider other potential interactions between the transmitters to insure that all three systems will be compatible with each other. The most important type of interaction is called intermodulation (IM), and it arises when signals are applied to "non-linear" circuits. (See Figure 3-4.)

A characteristic of a non-linear circuit is that its output contains "new" signals in addition to the original signals that were applied to the circuit. These additional signals are called IM products and are produced within the circuit components themselves. The frequencies of IM products are mathematically related to the original transmitter frequencies. Specifically, they consist of sums and differences of the original frequencies, multiples of the original frequencies, and sums and differences of the multiples. Non-linear circuits are intrinsic to the design of wireless components and include the output stages of transmitters

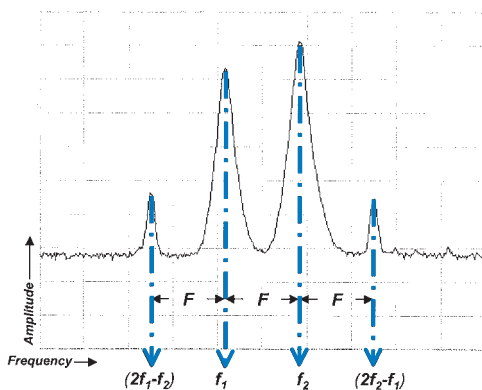

Figure 3-5: two-transmitter intermodulation

and the input stages of receivers. The "mixer" stage at the receiver input is an example of a non-linear circuit: recall that it is designed to produce a "difference" frequency that becomes the intermediate frequency (IF) for subsequent stages.

IM can occur when transmitters are in close proximity to each other. The signal from each transmitter generates IM products in the output stage of the other. These new signals are transmitted along with the original signals and can be picked up by receivers operating at the corresponding IM frequencies. (See Figure 3-7.)

IM can also occur when transmitters are operated very close to receivers. In this case IM products are generated in the receiver input stage which can interfere with the desired signal or be detected by the receiver if the desired signal (transmitter) is not present.

The strongest IM products are the two so-called 3rd order products produced by two adjacent transmitters operating at frequency f_1 and frequency f_2 , where f_1 is lower than f_2 . The resulting IM products may be calculated as:

$$IM1 = (2 \times f_1) - f_2$$

$$IM2 = (2 \times f_2) - f_1$$

If the interval between f_1 and f_2 is F , then $IM1 = f_1 - F$ and $IM2 = f_2 + F$. That is, one IM will appear exactly at interval F above the upper frequency f_2 while the other IM will appear exactly at interval F below the lower frequency. For example, if $f_1 = 180\text{MHz}$ and $f_2 = 190\text{MHz}$, then $F = 10\text{MHz}$. Thus, $IM1 = 170\text{MHz}$ and $IM2 = 200\text{MHz}$. (See Figure 3-5.)

In addition to IM products generated by interaction between two transmitters, other IM products are generated by interaction between three transmitters in a similar fashion. (See Figure 3-6.) In order to avoid potential IM problems most manufacturers recommend a minimum margin of 250 kHz (0.25 MHz) between any 3rd order

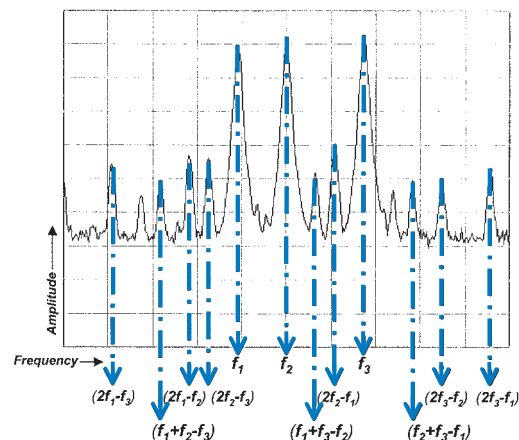

Figure 3-6: three-transmitter intermodulation

Selection and Operation of WIRELESS Microphone Systems

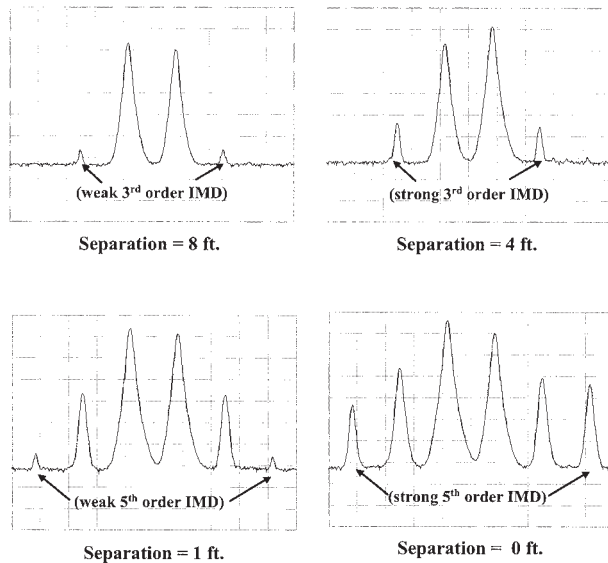

Figure 3-7: two-transmitter IMD strength vs. transmitter separation

IM product and any operating frequency. This further restricts available frequency choices as the number of simultaneous systems increases.

It should be apparent from this discussion that the prediction of potential compatibility problems due to IM products is best left to computer programs. The complexity increases exponentially for additional systems: a group of 10 wireless microphone systems involves thousands of calculations. See Appendix 1 for details on calculation of IMD products.

Internal frequency Interactions: LO, IF, Crystal Multipliers

In addition to frequency conflicts due to intermodulation between operating frequencies there are certain other sources of potential conflicts due to the various "internal" frequencies present in the normal operation of transmitters and receivers. These differ from manufacturer to manufacturer and even from system to system from the same manufacturer.

One such source is the local oscillator (LO) of the receiver itself. Although this is a low-level signal which is generally confined within the receiver, it is possible for the local oscillator of one receiver to be picked up by another receiver tuned to that LO frequency if they or their antennas are in close proximity to each other (stacked, for instance). For example, assuming a typical intermediate frequency (IF) of 10.7 MHz, a receiver tuned to 200.7 MHz would have its LO operating at 190.0 MHz. Another receiver tuned to 190 MHz should not be used close to the first receiver because the second unit could pick up the LO of the first, especially if the 190 MHz transmitter is turned off or is operating at a great distance. (See Figure 3-8.) Good design and shielding in receivers and physical separation of receivers will minimize the possibility of LO interference. For multiple units, active antenna splitters will effectively isolate antenna inputs from each other. However, it is still recommended that operating frequencies be chosen to avoid LO frequencies by at least 250 KHz.

An "image" frequency is another source of possible interference. In a receiver, recall that the frequency of the local oscillator (LO) always differs from the frequency of the received signal by an amount equal to the intermediate frequency (IF). Specifically, the operating frequency is above

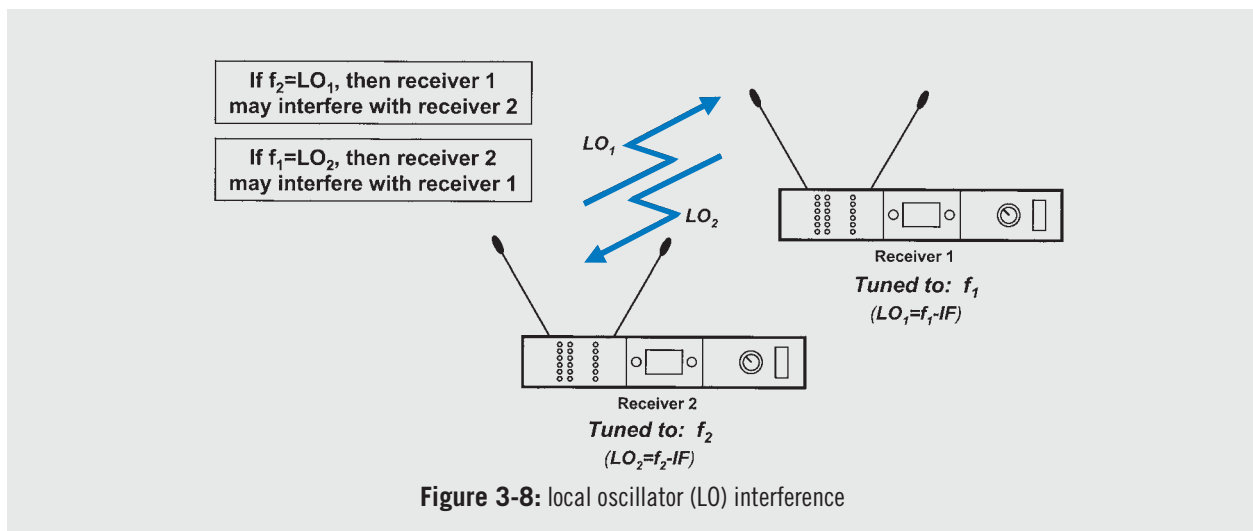

Figure 3-8: local oscillator (LO) interference

the local oscillator frequency by an interval equal to the IF. When these two frequencies are applied to the mixer section (a non-linear circuit) one of the output frequencies of the mixer is this difference frequency (the IF), which is the tuned frequency of the subsequent IF stage filters.

If the frequency of a second signal is at the same interval below the local oscillator frequency, the difference between this second frequency and the LO frequency would again be equal to the intermediate frequency (IF). The mixer stage does not discriminate between "positive" or "negative" frequency differences. If this second (lower) frequency enters the mixer stage, it will result in another (difference) signal getting to the IF stages and causing possible interference. This lower frequency is called the "image" of the original frequency. Again, assuming an IF of 10.7 MHz, a receiver tuned to 200.7 MHz would have its LO at 190.0 MHz. A signal from another transmitter at 179.3 MHz would appear as an image frequency since it is 10.7 MHz below the LO frequency or 21.4 MHz below the operating frequency.

The image frequency differs from the operating frequency by an amount equal to two times the intermediate frequency ($2 \times IF$). (See Figures 3-9 a & b.) The image frequency will be below the operating frequency for a high-side injection receiver and above the operating frequency for a low-side injection receiver. Thus the image frequency for the typical single conversion receiver is at least 20 MHz away from the operating frequency. Double conversion receivers, which have a relatively high first IF (50 MHz typical), have image frequencies which are even farther (>100 MHz typical) away from the operating frequency. In most cases, the front end of the receiver should be able to reject an image frequency unless it is extremely strong. Nevertheless, it is recommended that operating frequencies be chosen to be at least 250 KHz from any image frequency.

The last internal frequency issue concerns the VCO in crystal controlled transmitters. Recall that the actual VCO frequency is a relatively low radio frequency that is multiplied to obtain the final transmitter frequency. A small amount of the original crystal frequency remains after each multiplier stage. Thus the output signal includes not only the final operating frequency but also low-level "spurs" or spurious emissions due to the multipliers. These spurs occur above and below the operating frequency at intervals equal to "harmonics" (multiples) of the original crystal frequency.

For example, assuming a $9 \times$ multiplier, a 180 MHz transmitter would have a 20 MHz crystal frequency. This would produce spurs at 160 MHz and 200 MHz, 140 MHz and 220 MHz, etc. Good transmitter design will minimize the amplitude of such crystal harmonics but, again, additional receivers should be chosen to avoid these frequencies by at least 250 KHz. (See Figure 3-10.)

Frequency-synthesized transmitters do not produce spurious emissions of this type because they do not employ multipliers. However, both types of transmitters can produce other spurious emissions due to power regulating circuitry, parasitic oscillations, carrier harmonics, etc. These emissions can all be controlled through careful design.

It can be seen that the calculation of both local oscillator conflicts and image frequencies depends on the intermediate frequency (IF) of the receiver while calculation of crystal harmonics depends on the number of multipliers in the transmitter. If receivers with different IFs or transmitters with different multipliers are being used together (i.e. units from different manufacturers) this must be taken into account in compatibility analysis. Unfortunately, only a few proprietary computer programs for frequency selection have this capability. Input to most of these programs assumes that all units are of the same design. For this reason, accurate prediction of compatibility between systems of different design is not always possible.

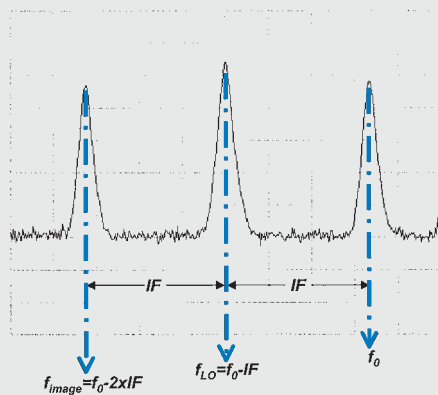

Figure 3-9a: image frequency interference (low-side injection)

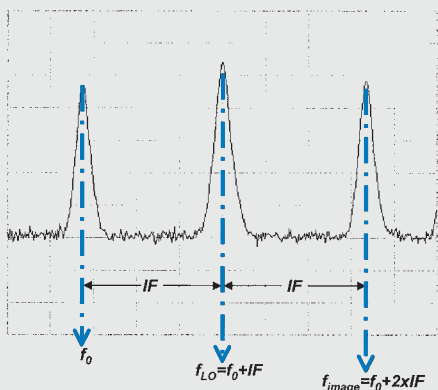
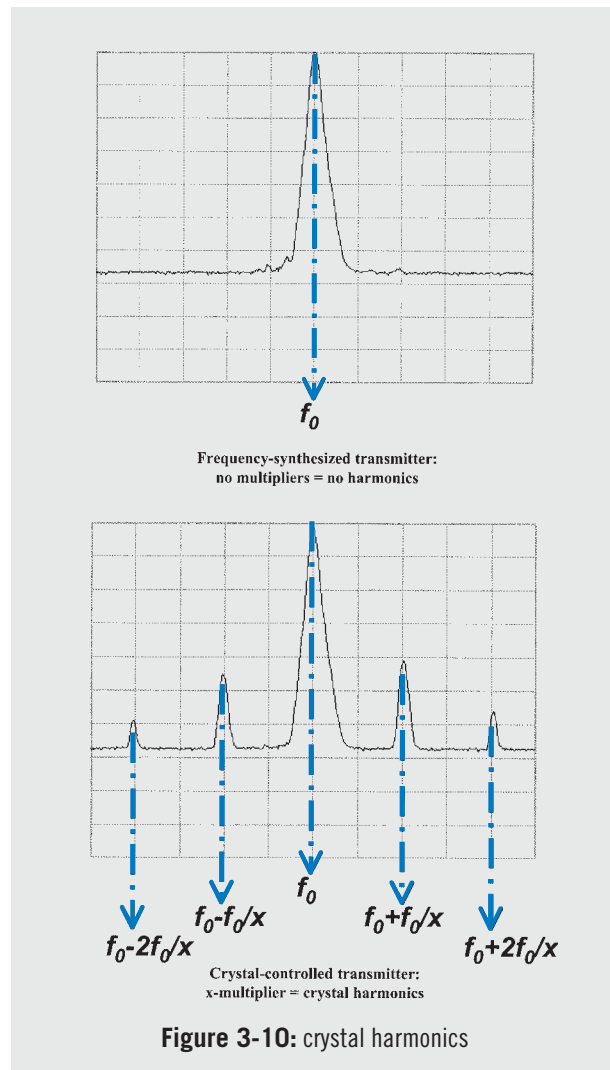

Figure 3-9b: image frequency interference (high-side injection)

Selection and Operation of WIRELESS Microphone Systems



Non-System Radio Interference

Even though a group of wireless microphone systems may be carefully chosen to avoid mutual interference there always exists the possibility of interference from non-system sources. These sources fall into two categories: broadcast (including television and other defined radio sources) and non-broadcast (narrow band or broadband sources of radio noise). We will look at each of these sources in terms of potential problems and possible solutions.

Broadcast Television

In the US, and many other countries, broadcast television is undergoing a transition from analog to digital. This transition affects wireless audio systems in several ways: more "occupied" TV channels, no "open" space in DTV channels, and future "re-allocation" of existing TV channels.

Nearly all full power television stations in the US are now broadcasting only digital signals (DTV). A few stations (mainly along international borders) and some low-power stations still broadcast an analog signal. Though both types of signal occupy similar channel "blocks", the nature of the signal within the channel is quite different. An analog TV transmission consists of three separate signals, each at a specified carrier frequency within a 6 MHz block (in the US). (See Figure 3-11a.) The picture or "video" information is an AM signal at 1.25 MHz above the bottom (low frequency end) of the block. The sound or "audio" information is an FM signal located at 0.25 MHz below the top (high frequency end) of the block. The color or "chroma" information is an AM signal at 3.58 MHz above the video signal. The energy distribution and occupied bandwidth of these three signals is not equal: the video signal has the highest power and widest bandwidth, followed by the audio signal and finally the chroma signal with the lowest power and smallest bandwidth.

A digital TV transmission consists of a continuous signal that occupies the entire 6 MHz block. (See Figure 3-11b.) All of the video, audio, and color information is digitally encoded into this signal along with a variety of other data, control, and secondary audio information. It is possible for the DTV transmission to carry one high definition television signal (HDTV) and/or multiple standard definition television signals. The energy distribution within a DTV channel is essentially uniform. However, the average signal level of a DTV transmission is somewhat less than the levels of the video and audio signals in an analog TV transmission.

As indicated previously, the primary users of both high-band VHF and low-band UHF frequencies are broadcast television stations. In the US these are VHF TV channels 7 through 13 and now UHF TV channels 14 through 51. Each TV channel is allotted a 6 MHz block for its transmission. (See Figure 3-12 for a diagram of designated blocks.) VHF channel 7 begins at 174.0 MHz and extends to 180.0 MHz, channel 8 occupies 180-186 MHz and so on up to channel 13 at 210-216 MHz. UHF channel 14 occupies 470-476 MHz with successive channels up to channel 51 at 692-698 MHz.

The 6 MHz/TV channel block is found in the US, the rest of North America, South America and Japan. Other countries, most of Europe and India for example, use a 7 MHz/TV channel block, while France and China, among others, use an 8 MHz/TV channel block. For analog transmission in these other systems, the video and audio signals are located at the same frequencies relative to the channel boundaries as in the 6 MHz systems, but the frequency of the chroma signal differs slightly in each to accommodate the various color systems: NTSC (6 MHz),

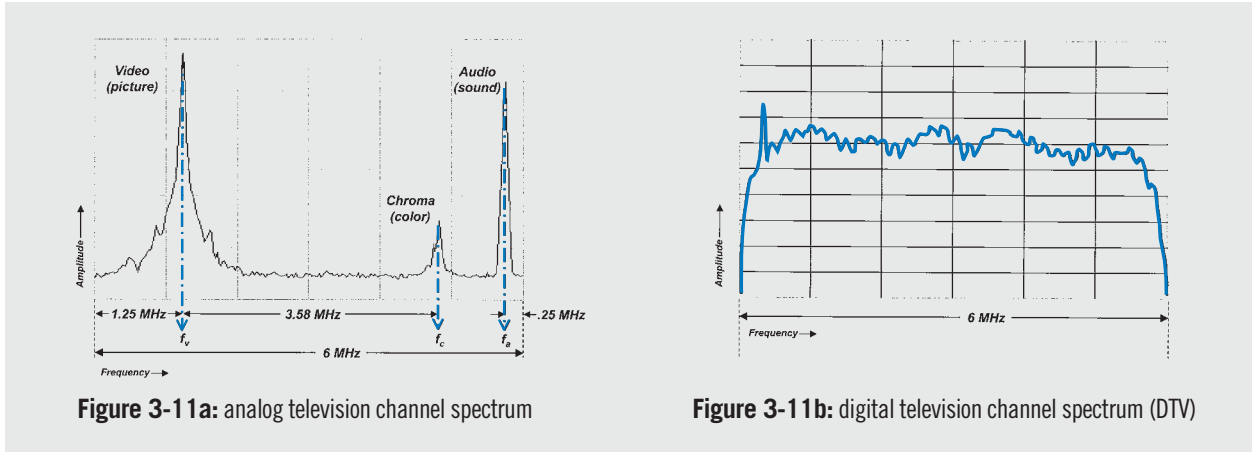

Figure 3-11b: digital television channel spectrum (DTV)

PAL (7 MHz), and SECAM (8 MHz). DTV proposals for all systems specify the appropriate TV channel block sizes.

Traditionally, to avoid potential interference between broadcast television stations, regulatory agencies have not allowed adjacent analog TV channel operation in a given geographic area. For example, in the US, if a local analog TV channel 9 existed, then analog channels 8 and 10 would be vacant. These vacant channels could then be used by wireless microphone systems with little concern for television interference.

Historically, the prohibition of adjacent channels guaranteed the existence of certain vacant TV channels in a given area. The advent of DTV has removed this guarantee: DTV channels are allowed to exist adjacent to each other and also adjacent to existing analog TV channels. This has resulted not only in more densely spaced TV channels but also in difficulty using certain "pre-selected" frequency compatibility schemes.

The effects of interference from television broadcast are dependent on the type of television signal (analog or DTV) and the strength of the television signal, as well as the location and the operating frequency of the wireless microphone system. Direct conflicts with any of the three signals that make up an analog TV transmission can produce noise, distortion, and short range or dropout. Pickup of the video or chroma signals (which are AM) may cause distinct "buzz" in the wireless receiver, while pickup of the audio signal (FM) may result in the TV sound being heard.

Direct conflict with a DTV signal also causes short range or dropouts. Though it is not possible for an analog receiver to "hear" anything from a digital transmission, the DTV signal acts as a very strong broadband radio noise source. In some systems this may result in increased noise or distortion in the audio output. Since there are no "unoccupied" frequencies in a DTV signal it is generally not possible to operate anywhere within a very strong DTV channel.

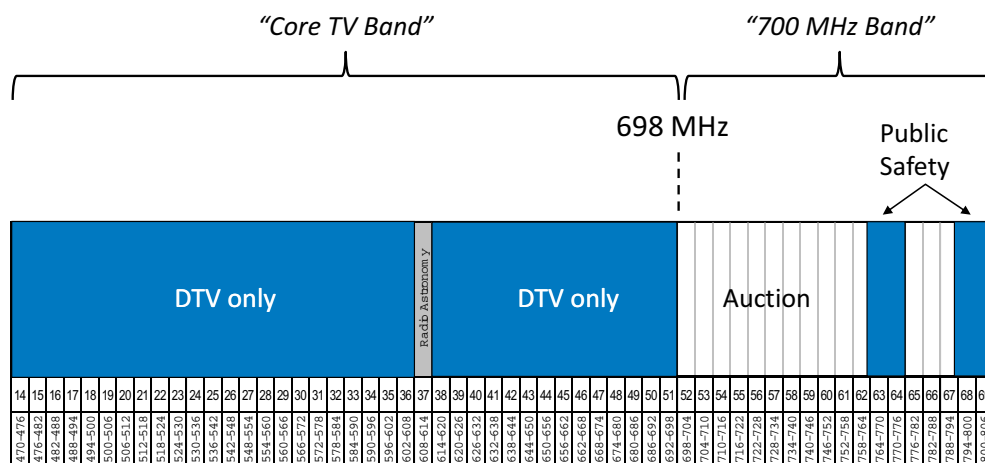

Figure 3-12: DTV transition and 700 MHz Re-Allocation

Selection and Operation of

WIRELESS

Microphone Systems

The most effective solution for broadcast television interference is to avoid using frequencies of local active TV channels. Television transmitters may operate at power levels up to several million watts while wireless microphone systems typically have only less than 50 mW (fifty one- thousandths of one watt!) of output power. For this reason it is unwise to choose wireless microphone system frequencies that fall in an active local TV channel block.

"Local" is generally considered to be up to 50 or 60 miles, depending on the coverage area of the particular TV transmitter and on the location of the wireless microphone system. Indoor setups are at less risk than outdoor setups because building structures will usually strongly attenuate TV signals. Nevertheless, since the locations and assignments of television stations are well known it is relatively easy to choose wireless microphone system frequencies to avoid them in a particular area.

One consequence of the relatively dense TV channel

distribution in the US is that it is not generally possible to use a given set of wireless microphone frequencies everywhere in the country. As the distribution of vacant channels changes from city to city it is almost inevitable that a fixed-frequency system will experience interference from a television station in some location. For this reason, nearly all current wireless systems are "frequency-agile" (tuneable) so that their operating frequencies may be changed as needed.

Many manufacturers pre-select groups of wireless microphone system frequencies based on the availability of locally vacant TV channels. If the TV channels are known then it is relatively straightforward to choose appropriate wireless frequencies for that location. Information on TV channel distribution throughout the US is widely available from manufacturers and other sources. It is usually sufficient to indicate the destination of the wireless equipment at the time that it is specified in order to avoid broadcast television interference.

Wireless Systems in the Post-DTV Transition Era

In the United States, the Federal Communications Commission (FCC) has been supervising the transition of broadcast television from its traditional analog format to an all-digital format (DTV). In the process, the commission has also been mandated to increase efficient use of TV spectrum and to increase the amount of spectrum available for public safety and other wireless services. Therefore, the transition has provided both consolidation of the broadcast spectrum and the reallocation of the resulting open spectrum for other uses.

The FCC has consigned all broadcast television into a "core" band, TV Channels 2-51. All existing TV stations above Channel 51 have migrated into the core band. The upper frequency limit of the broadcast band is now 698 MHz and (nearly) all full-power TV stations are now digital. All former television spectrum above Channel 51 (698-806 MHz) has now been reallocated for new services. This spectrum is generally referred to as the "700 MHz" band. Within the 700 MHz band, most of this spectrum has been auctioned by competitive bidding to telecommunications companies while the rest has been set aside for public safety services.

The telecommunications spectrum, 698-763 MHz (roughly TV 52-62) and 775-793 MHz (roughly TV 65-67), is being developed for various services such as broadband internet access, streaming video, and other

digital data transmission. The public safety bands total 24 MHz in two "paired" bands: 763-775 MHz (roughly TV 63-64) for fixed transmitters and 793-805 MHz (roughly TV 68-69) for mobile transmitters.

For both statutory and practical reasons, the 700 MHz band is no longer available for use by wireless microphones or other wireless systems. Not only will they no longer be authorized in this spectrum, but also the interference from new services in this band will make operation of such systems unreliable at best. For this reason, manufacturers and distributors of wireless systems in the US market are no longer supplying wireless systems in the 700 MHz band. New wireless systems continue to be available mainly in the core television band (TV 2-51) and in a few other narrow frequency bands.

For a complete list of U.S. television frequencies...

see Appendix B on page 61.

Coordinating frequencies?

Looking for unoccupied television channels?

Check out: www.shure.com/frequency

or www.shure.com/faq

White Space Devices

"White Space Devices", now called Television Band Devices (TVBD), are a new type of unlicensed radio system intended primarily to increase wireless broadband Internet access. "White Space" refers to unused TV channels in a given geographic area. Of course, most professional wireless audio systems already operate on those same unused TV channels, raising the possibility of interference from TVBD systems. Though no such devices have been placed into public use as yet, the FCC has defined the basic parameters of TVBD operation to include significant protection methods for existing wireless microphones.

A TVBD can be classified as a "fixed" device or a "portable" device. A fixed TVBD can operate in a specific location at a power level up to 4 watts. However, a fixed TVBD cannot operate on or adjacent to an active TV channel or public safety channel. By comparison, a portable TVBD can operate only at a power level up to 100mW. Though it also cannot operate on an active TV channel, a portable TVBD can operate adjacent to an active TV channel but at a reduced power of 40mW. Further, though a fixed TVBD can operate throughout the UHF broadcast range, a portable TVBD cannot operate in the TV14-TV20 range.

The two principle protection methods required to be implemented in TVBD operation are a "protected channel" plan and a "geo-location/database access" plan. The protected channel plan is intended to provide at least two TVBD-free TV channels at any location in the US. In most places, these two channels will be the first unused TV channel above TV37 and the first unused TV channel below TV37. For example, in an area with a local TV36 but no TV35, then TV35 would be the protected channel below TV37. Similarly, in an area with a local TV38 and TV39, but no TV40, then TV40 would be the protected channel above TV37.

In addition to the two defined protected TV channels, cities with TV stations and/or public safety

channels in the TV14-TV20 range may have additional TVBD-free TV channels. This is because only fixed TVBD devices can operate in this range, but they cannot operate adjacent to an active TV channel or public safety channel. In such a location, those adjacent channels would also be protected from TVBD activity.

The geo-location/database plan requires that each TVBD incorporates the capability to accurately know its geographic location and the capability to access a database of excluded frequencies for that location. Each time a TVBD is activated it must access the database before transmitting, as well as at least once per day in continuous operation. The database will include permanent exclusions such as local active TV channels as well as the local protected channels defined above. The high-power fixed TVBD must observe a 1 km exclusion zone while the portable TVBD must maintain a 400m distance.

Additionally, the database will list temporary exclusions to protect registered wireless systems operating on specific frequencies at specific times. Both licensed and unlicensed wireless users may register frequencies in the database, though licensed users will be allowed to register within 48 hours of an event while unlicensed users must register at least 30 days before their events. The database and its registration procedure are to be managed by independent entities approved by the FCC.

Note that the potential addition of TVBD operations to the TV spectrum does not restrict the use of wireless microphone systems to the "protected" TV channels. Wireless microphones continue to be legal to operate on any unused channel throughout the entire television band. However, the protected TV channels offer a safe haven from TVBD interference for wireless microphones operating in those channels, without the necessity for registration.

Broadcast Radio

High-band VHF wireless FM systems are not generally subject to interference from commercial AM or FM radio stations. Both bands are well below the VHF band and in particular, these systems are not typically sensitive to moderate AM signals. UHF systems are even less likely to respond to commercial radio sources since the UHF band is >300 MHz above the top of the FM band. However, occasional interference, in the form of distortion or short range, can occur in cases of extreme proximity to a high-power commercial radio transmitter.

Other Radio Services

Direct pickup of 2-way radio, pagers, business band, ham-radio etc. is rare. However, since some of these sources can be quite strong locally there is the possibility of interference due to intermodulation or if the source appears as an image frequency. For example, operating a walkie-talkie near a wireless receiver can cause noise, distortion or apparent loss of range.

In particular, the "travelling" wireless microphone system frequencies (169-172 MHz) share space with a number of unpredictable primary users including government (Coast Guard, Secret Service), industry (forestry, hydroelectric), land mobile and paging services. Direct pickup or inter-modulation from these sources is possible in this band. Symptoms may again include noise, loss of range or actual audio pickup.

Of course nearby use of other (unexpected) wireless microphone systems can create interference through inter-modulation or direct frequency conflict. Given the finite number of wireless frequencies available, especially in the "travelling" channels, it is always possible to encounter other wireless microphone users in locations such as hotels, convention centers, sports facilities, and news events.

Remedies for such interference involve identifying the interfering source if possible and relocating the source or the wireless microphone system to reduce proximity. If this is not sufficient it may be necessary to change the operating frequency of the wireless microphone system especially if the interfering source is a primary (licensed) user.

Non-Broadcast Sources

Non-broadcast sources are those that produce radio frequencies only as a by-product of their operation. There are three main types which are of concern to wireless use: digital audio/video devices, digital computers/controllers, and certain AC power equipment. Digital audio devices include: digital signal processors (DSP's) such as delays, reverbs, pitch shifters; digital recording and playback devices such as DAT recorders, CD players, hard drive recorders and

samplers; digital electronic musical instruments such as synthesizers, organs, and MIDI-controlled instruments. Digital video devices include cameras, camcorders, video switchers, video DSPs, and video editing systems.

Digital computing devices include: microprocessor equipped units (PC's, calculators), minicomputers (workstations) and main-frame computers. In addition, controllers for lighting, AV presentations, industrial equipment and certain video equipment contain microprocessors.

Digital devices can produce broad band RFI (radio frequency interference) in close proximity to the source. Any device which carries an FCC type approval label such as "Class B computing device" can be assumed to be a potential source of interference. The audible effect is usually high frequency noise or distortion and it generally only occurs when the receiver is close to the digital device and the transmitter is at a distance. Unfortunately, this is often the case when wireless receivers are located in or near racks of digital gear while the transmitters are being used on a stage.

The best remedy for this type of interference is to locate the receivers and antennas at least several feet from any digital device. In a rack of different equipment this would suggest mounting the wireless receivers at the top, analog equipment below that and digital equipment at the bottom. In extreme cases, choosing higher wireless frequencies may improve matters. However, as the speed (clock frequency) of digital equipment increases this technique will be less effective.

Occasional sources of apparent interference are mobile telephones and digital messaging products operating with GSM technology. Although transmit and receive frequencies of these devices are well outside the bands used by wireless audio equipment they may still cause audible effects. In particular, when GSM devices are in a "handshake" mode or transmitting data, they produce high levels of RFI that can be picked up directly by the audio circuits of wireless microphones as well as wired microphones and other audio devices. This can result in a characteristic buzzing or "chirping" sound in the affected equipment. Although newer professional audio products are more resistant to this effect, the best practice is to turn off any GSM mobile device that may be used within a few feet of any audio device.

Finally, any equipment that uses or controls high voltage or high current AC power can generate radio frequency interference (RFI). Examples include lighting dimmers and some types of gas discharge lamp supplies such as neon or fluorescent ballasts.

Audible effects of this type of source include buzz or hum in the signal. Again, the first remedy is to relocate the offending source or the wireless equipment to minimize pickup. In some cases special filtering may be applied to

the various power and connecting cables of both the source and the wireless equipment to block RFI from leaving the source or entering the wireless equipment.

A property of FM reception which can reduce the audibility of many types of interference is the so-called "capture effect." When multiple signals (close to the operating frequency) are present, the strongest signal will capture or lock-in the receiver. If the desired signal is sufficiently strong, the interfering signals may not be heard. Since the strength of the desired signal (the transmitter) is dependent on the operating distance, a nearby transmitter can often overcome weak or distant interference sources.

Range of Wireless Microphone Systems

A logical question concerning wireless performance is the transmission range of various systems. Unfortunately, the answer is much more complicated than a simple distance measurement. Ultimately, the receiver must be able to pick up a "useable" signal from the transmitter. "Useable" means that the strength of the desired signal is within the sensitivity range of the receiver and further that it is sufficiently stronger than (or different from) undesirable signals and RF noise to produce an acceptable signal-to-noise ratio at the audio output of the receiver. Elements that affect useability are the transmitter/antenna, the transmission path, the receiver/antenna and RFI. Some characteristics of these elements are controllable, some are not. (See Figure 3-13.)

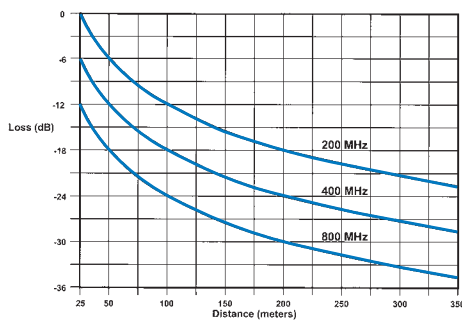

Figure 3-13: loss vs. distance vs. frequency

Important transmitter characteristics are power output and antenna efficiency. Maximum power is limited by government regulations and battery capability. Antenna efficiency is limited by size and design. Recall that the efficiency of typical wireless transmitter antennas is fairly low, about 10% or less for VHF. This means that for a 50 mW VHF transmitter the effective radiated power (ERP) is less than 5 mW. This may be further attenuated by proximity to the body or other lossy objects.

Important receiver characteristics are antenna efficiency, receiver sensitivity and the ability of the receiver

to reject unwanted signals and noise. Antenna efficiency is again limited by size and design but receiver antennas tend to be much more efficient than transmitter antennas since they can be made large enough to be better tuned to the proper frequency. Other receiver characteristics are limited by design. Both elements are limited by cost.

The transmission path is characterized by distance, intervening obstructions and propagation effects. Losses due to these characteristics are generally frequency dependent: the higher the frequency the greater the loss. Once the operating frequency is chosen, only the path length and antenna locations are controllable. These are usually limited by the application itself. Under good conditions (line-of-sight) at a distance of about 100 ft. the field strength of the signal from a 50 mW transmitter is on the order of 1000 uV/m, well within the range of sensitivity of a typical receiver.

Finally, RFI is characterized by its spectrum, that is, its distribution of amplitude and frequency. It typically consists of both broadband noise and discrete frequencies. However, its strength can be comparable to or greater than the desired signal in poor conditions. Except for a few predictable sources it is largely uncontrollable.

Rather than quote a specific maximum operating distance most manufacturers of wireless microphone systems give a "typical" range. For systems of the type discussed here (10-50 mW, VHF or UHF) the typical range may vary from 100 ft. to 1000 ft. The lower number represents a moderately severe environment while the upper figure might be achieved in absolute ideal conditions. Extremely poor conditions could result in a range of only 50 feet or less. It is impossible to accurately predict the range of an arbitrary wireless microphone system in an arbitrary application.

Spread Spectrum Transmission

A transmission technique that may have application to wireless microphone systems is known as "spread spectrum." The object of this technique is to improve performance by reducing interference effects and increasing efficiency of band utilization. Instead of concentrating the information and energy of the transmission at a single, continuous frequency, the signal is spread out over a wide radio frequency range. The two most common methods are "frequency hopping" and "direct sequence spreading."

Frequency hopping systems utilize a transmitter that changes its operating frequency many times per second according to a predetermined pseudo-random pattern. The receiver is synchronized with the transmitter so that it changes its operating frequency in exactly the same pattern. At any instant the system is operating on only one

Selection and Operation of

WIRELESS

Microphone Systems

frequency but over time the range of frequencies used may be several MHz. The information may be carried as an FM signal or as a digital signal. (See Figure 3-14.)

Direct sequence systems operate around a center frequency but the effective total modulation (bandwidth) of the signal is significantly increased. This is accomplished by modulating the phase of the carrier with a high-speed, pre-determined pseudo-random digital sequence (pattern). Again the receiver is synchronized with the transmitter according to the same pattern. In this system the information can be carried as an analog FM signal or as a digital signal, mixed with the phase modulating sequence. (See Figure 3-15.)

By spreading the transmission power of the desired signal over a greater portion of the radio spectrum, the average energy of the desired signal at any one frequency is reduced. This reduces the potential for interference from a particular transmitter. In addition, the receiver becomes less sensitive to undesirable radio sources at any one frequency because it spreads the energy of the interfering source over a wider range at much lower average level. It is not only possible to decrease certain radio interference effects but also to increase the number of users that may operate in a given band.

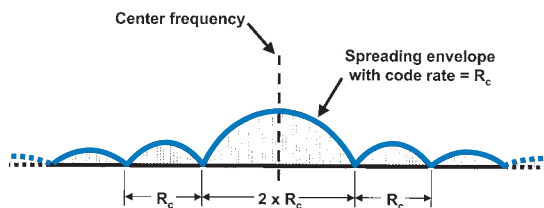

Figure 3-15: direct sequence spectrum

Historically, this technique has been applied to communication and data transmission, particularly in military applications. Presently it is found in some consumer cordless telephone equipment and has been used in at least one MIDI wireless microphone system. However, current spread spectrum technology may not lend itself to the highest fidelity audio transmission in a wireless microphone package without significant tradeoffs in size and cost.

Digital Wireless Systems

As other links in the audio chain have been converted to the digital domain it is of interest to look at the impact of digital technology on wireless transmission systems. Digital techniques can be applied to professional wireless in several ways, each offering potential benefits. The first level of application has been the use of digital control circuits for various tasks such as frequency selection, diversity antenna switching and most display functions. Nearly all frequency-agile wireless systems benefit from the use of digital controls and digital displays.

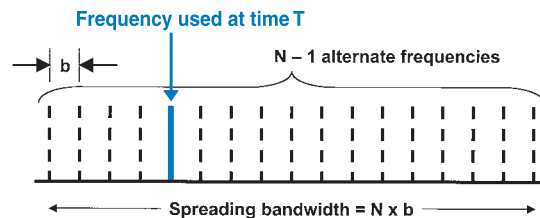

Figure 3-14: frequency hopping spectrum

The next digital application level employs DSP (Digital Signal Processing) to replace traditional analog companding circuits. An audio DSP circuit is used in the transmitter to optimize the input signal for transmission and a complementary audio DSP is used in the receiver to optimize the output signal. The radio transmission path is still in the analog domain. Benefits may include increased audio dynamic range, decreased companding artifacts, and wider frequency response.

The highest level of digital implementation uses a fully digital transmission path. The input signal is digitized in the transmitter and remains in the digital domain until the receiver output. It is even possible to output a digital signal from the receiver to subsequent digital equipment. Potential benefits of an all-digital wireless approach include both improved audio quality and improved radio transmission. However, the technical requirements are not trivial and the inevitable compromise between performance and cost requires some difficult decisions.

In concept, fully digital wireless transmission is simple. Add an analog-to-digital (A/D) converter at the input of the transmitter. Transmit the resulting digital information to the receiver. Demodulate the digital information and add a complementary digital-to-analog (D/A) converter at the output of the receiver. The ultimate limitation lies in the amount of digital information that must be reliably transmitted for acceptable audio quality.

In general, information transmission techniques (wired or wireless) must balance bandwidth limitations with hardware (and software) complexity. Bandwidth refers to the range of frequencies and/or amplitudes used to convey the information. In audio, a frequency range of 20-20,000Hz and an amplitude range (dynamic range) of 120dB is perhaps the ultimate goal. However, a frequency range of 300-3000Hz and a dynamic range of 30dB are sufficient for telephone-quality speech. As expected, high fidelity audio equipment tends to be more complex and costly than telephone equipment.

In analog FM radio systems, audio fidelity is greatly dependent on allowable deviation, which is related to RF bandwidth: wider deviation increases occupied bandwidth. Walkie-talkies use less bandwidth than wireless microphones. Even so, bandwidth limitations necessitate the use of companders to achieve acceptable dynamic range in most high quality analog wireless systems.

The bandwidth required for a high fidelity digital wireless system depends on the amount of digital information transmitted and the transmission rate. In practice, the bandwidth is limited by physical and regulatory requirements. This effectively constrains the amount and rate of information that can be transmitted. Ultimately, the fidelity and reliability of a digital wireless system is limited by these same bandwidth restrictions.

A digital representation of an analog signal is generated by sampling the analog waveform at some rate. To avoid errors in the digital representation of an audio signal, the sampling rate must be at least twice the highest audio frequency desired. Thus, digitizing a 20kHz audio signal requires a sampling rate of at least 40kHz. CD audio uses a 44.1kHz sampling rate while advanced systems use sampling rates of 48kHz or higher.

The measurement of each sample is represented by a digital number. The resolution (accuracy) of this value is proportional to the number of "bits" in the digital number, where each bit can be "0" or "1". The greater the number of bits, the more accurate is the sampled value. For example, an 8-bit sample represents 256 values, a 16-bit (CD quality) sample has 65,536 values, and a 24-bit sample represents more than 16 million values.

The bit rate of a digital signal is the resolution multiplied by the sampling rate. CD audio is 16 bits x 44.1kHz or 705.6k bits-per-second (bps). Higher performance digital systems that operate at a resolution of 24 bits and a sampling rate of 48kHz generate a bit rate of 1152kbps.

In the simplest form of digital audio transmission, the required bandwidth of such a signal would be equal to the bit rate. That is, to transmit CD-quality audio would require a bandwidth of 705.6 kHz while a high performance signal would require 1152kHz. Based on allowable occupied bandwidth limits, it is not possible (or legal) to transmit such a signal. For comparison, cellular telephones use 8-bit resolution and a 6kHz sample rate, resulting in a data rate of only 48kbps. The resulting audio quality limitation is obvious.

To deliver the highest quality audio signal in a practical digital wireless system, it is necessary to fit the transmitted data within the allowable bandwidth limits using various data management techniques. These techniques are implemented by first "coding" the data in the transmitter and then "decoding" the transmitted data in the receiver. This process is conceptually similar to "companding" processes in analog FM systems, but here it is carried out in the digital domain. Properly implemented, the resulting audio can have wider frequency response, better dynamic range, and less audible "artifacts" than traditional analog systems. In addition, the digital transmission scheme can offer some improvement in radio performance as well as the possibility of data encryption.

The basic method of transmitting digital data in a radio signal involves modulating the carrier in discrete steps, a process called "shift keying". This can be done with frequency (Frequency Shift Keying or FSK), amplitude (Amplitude Shift Keying or ASK), or phase (Phase Shift Keying or PSK). If the shift key signal has two possible values (corresponding to a bit value of "0" or "1") then the data rate is equal to the bit rate. For example, a 2-FSK signal shifts between two possible frequencies where one frequency represents a "0" and the other a "1". (See Figure 3-16.) However, it is possible to send more than one bit per cycle by coding multiple bits into "symbols". The symbol rate is equal to the bit rate divided by the number of bits transmitted with each symbol.

The theoretical occupied bandwidth of such a coded digital transmission is now equal to the symbol rate. In this way it is possible to transmit the same amount of data in less bandwidth. For example, QPSK coding (Quadrature Phase Shift Keying) has four possible values (00, 01, 10, 11) and can thus send two bits per symbol, resulting in half the required bandwidth of a non-coded signal. (See Figure 3-17.) Likewise, 8-PSK (Eight Phase Shift Keying) has eight possible values (000, 001, 010, 011, 100, 101, 110, 111) accommodating three bits per symbol, thus reducing the required bandwidth to one-third of a non-coded signal.

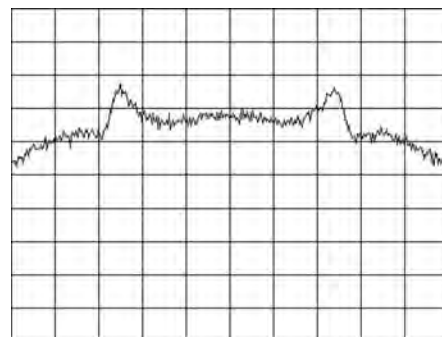

Figure 3-16: 2FSK

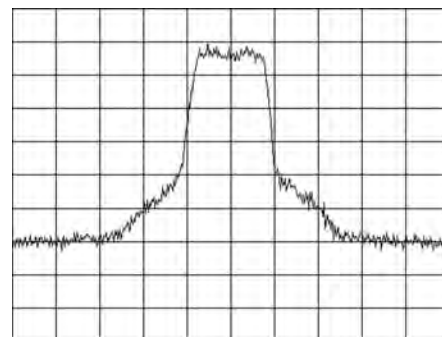

Figure 3-17: QPSK

However, even with the reduced bandwidth requirements of higher order symbol coding techniques it is still not generally possible to transmit the entire data stream within the available bandwidth. To reduce the data rate to manageable size some form of data compression must be employed.

Data compression schemes can be characterized as "lossless" or "lossy". A lossless scheme reduces the data stream by coding redundant data into shorter forms. Decoding "lossless" compressed data will exactly restore the entire original data stream. Lossless compression is effective on data that exhibits significant redundancy such as text, spreadsheets, and certain graphic files. It does not provide a high degree of compression on typical digital audio data.

A lossy data compression scheme discards a certain amount of the original data stream, generally the "least significant" parts. For audio data, there are various methods that rely on the characteristics and limitations of human audio perception. The best lossy compression schemes result in audio that is nearly indistinguishable from the original. However, each method involves trade-offs between the degree of compression, audio quality, and processing time (latency).

The algorithm (mathematical formula) used in a particular data compression scheme is called a "codec" (code – decode), indicating the two-step nature of the process. Examples of codecs used in digital audio recording are MP3 and AAC. Each of these has selectable bit rates, the lowest offering small file size with reduced fidelity and the highest offering improved audio fidelity at the expense of larger file size.

However, these standard codecs are relatively slow, introducing latency (delay) of up to 100ms in the process. In addition to the codec, other sources of latency include A/D and D/A converters, as well as other DSP elements. Though this may not be a problem in a music playback system, it would be unacceptable for a live performance wireless audio system. In live audio applications, latency must be kept as short as possible, ideally less than 5ms. Above 5ms, the latency becomes generally noticeable and when it exceeds 20ms, musical timing can be affected. For comparison, cellular telephone connections may have latency greater than 200ms. This leads to well-known effects such as unnatural pauses in conversation and the tendency for each person to speak over the words of the other.

Professional digital wireless systems use specialized codecs that are capable of excellent audio quality and low latency within allowable radio bandwidth limitations. For example, in the 900MHz band, the allowable bandwidth is about 500kHz. Assuming a simple 1-bit per symbol

transmission, an 1152kbps data stream (48kHz x 24 bit) will require about 3:1 data compression ($1152 / 3 = 384$ kbps). In the standard UHF broadcast band, the allowable bandwidth is less than 200kHz. Again, assuming standard coding, the same 1152kbps data stream may require as much as 9:1 data compression.

A typical transmit coding scheme involves digitally dividing the full audio bandwidth into a number of sub-bands. Each sub-band is processed separately to deliver the desired amount of data compression. The sub-band data are assembled into a digital data stream which is used to modulate the transmitter output. Depending on allowable bandwidth and other limitations, the modulation is typically FSK or PSK.

In the matching receiver, the incoming data stream is disassembled into corresponding sub-band data. Each sub-band is decoded to reproduce its original counterpart. Finally, the decoded sub-band data are combined to reconstruct the original full-bandwidth audio signal. It should be noted that the parameters for each element in this process have to be very carefully chosen to achieve the highest audio quality and the lowest latency consistent with both hardware and software limitations.

One necessary addition to the data stream is control and timing information to achieve synchronization between the transmitter and receiver processes. Other transmitted data may include battery condition, transmitter type, gain settings, and data encryption settings. A certain amount of bandwidth is always required for these functions, further limiting the maximum data rate.

The final consideration for digital systems is data transmission error. The integrity of the transmitted data stream can be adversely affected by radio interference, multi-path, signal fading, etc. The likelihood of errors also increases with the complexity of the transmission scheme. To reduce the effects of data loss, various error management techniques are employed. Some of these involve transmitting extra data to provide not only a means of detecting data loss but also a means of correcting some of those losses. However, since error correction methods may increase occupied bandwidth as well as processing complexity/latency, complete error elimination is not possible. Nevertheless, practical digital wireless system can be made very robust in the presence of transmission errors and able to recover gracefully from any severe data loss.

The general design of a digital audio transmitter begins with an analog audio preamp followed by an initial ADC (analog-to-digital converter). The resulting uncompressed digital data stream passes to a DSP that performs the necessary data compression such as the sub-band coding described above. The digital data is processed into a stream

of digital "words" that contain the coded audio as well as timing and error correction information which is then passed to the RF transmitter section. The data must pass through a DAC (digital-to-analog converter) near the end of this process because the actual transmitter is an analog device. In some designs the DAC is part of the DSP device while in others it is part of the transmitter itself. The transmitter is tunable by means of a frequency-synthesized VCO that can produce an AM, FM, or PM output as needed. Finally, an RF amplifier provides the necessary output power. (See Figure 3-18.)

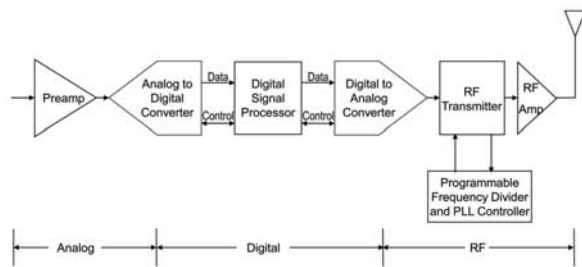

Figure 3-18: frequency-synthesized digital transmitter

The general design of a digital audio receiver begins with an analog front-end filter followed by a single analog down-conversion stage. This stage is tunable by means of a frequency-synthesized local oscillator. The resulting intermediate frequency signal is very precisely filtered and passed to an ADC. The digital data stream passes to a DSP that established proper timing for decoding the sub-band information, applies error correction, and reconstructs the original digital audio data. A final DAC produces the analog signal for the audio output amplifier. Again, the DSP process may consist of multiple devices. (See Figure 3-19.)

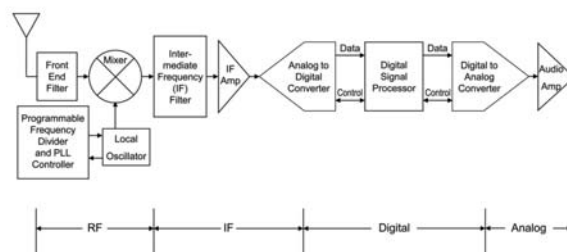

Figure 3-19: frequency-synthesized digital receiver

Operation of Wireless Systems Outside of the U.S.

Allocation and regulation of radio frequencies is supervised by specific government agencies in each country, with the result that allowable (legal) frequencies and frequency bands differ from country to country. In addition to frequency, these agencies typically specify other aspects of the equipment itself. They include: allowable transmitter power, maximum deviation (for FM), spurious emissions, etc. These specifications may differ from one band to another and may further differ from one type of user to another within the same band. For this reason, it is not possible to select a specific frequency or even frequency band that is (legally) useable in all parts of the world. Furthermore, it is not possible to design a single type of wireless equipment that will satisfy the specifications of all or even most of these agencies around the globe.

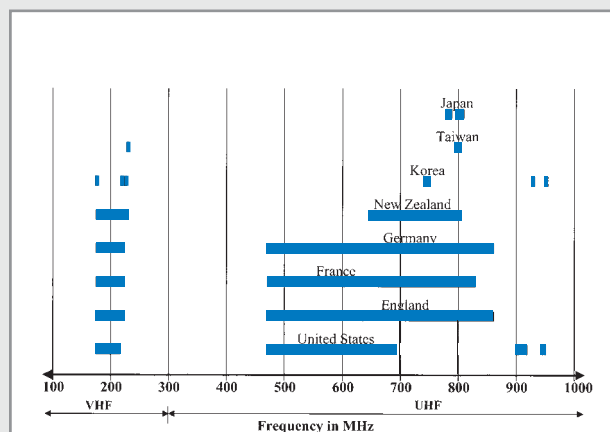

Figure 3-20: international wireless frequencies

CHAPTER FOUR

WIRELESS SYSTEM SELECTION AND SETUP

System Selection

The proper selection of a wireless microphone system consists of several steps based on the intended application and on the capabilities and limitations of the equipment required for that application. It should be remembered that while wireless microphone systems cannot ultimately be as consistent and reliable as wired systems, the performance of currently available wireless can be very good, allowing excellent results to be obtained. Following these steps will insure selection of the best system(s) for a given application.

1) Define the application. This definition should include the intended sound source (voice, instrument, etc.) and the intended sound destination (sound system, recording or broadcast). It must also include a description of the physical setting (architectural and acoustic features). Any special requirements or limitations should also be noted: cosmetics, range, maintenance, other possible sources of RF interference, etc. Finally, the desired performance level must be defined: radio quality, audio quality, and overall reliability.

2) Choose the microphone (or other source) type. The application will usually determine which microphone physical design is required: a lavalier or clip-on type attached to clothing, or a head-worn type, both for hands-free use; a handheld type for a vocalist or when the microphone must be passed around to different users; a connecting cable when an electric musical instrument or other non-microphone source is used. Other microphone characteristics (transducer type, frequency response, and directionality) are dictated by acoustic concerns. As mentioned earlier, the microphone choice for a wireless application should be made using the same criteria as for a wired application.

3) Choose the transmitter type. The microphone choice will usually determine the required transmitter type (handheld, bodypack or plug-on), again based on the application. General features to consider include: antenna style (internal or external), control functions and location (power, muting, gain, tuning), indicators (power, battery condition), batteries (operating life, type, accessibility), and physical description (size, shape, weight, finish, material). For handheld and plug-on types interchangeability of microphone elements may be an option. For bodypack transmitters, inputs may be hard-wired or detachable. Multi-use inputs are often desirable and may be characterized by connector type, wiring scheme and electrical capability (impedance, level, bias voltage, etc.).

4) Choose the receiver type. The basic choice is between diversity and non-diversity. For reasons mentioned in the receiver section above, diversity receivers are recommended for all but the most budget-conscious applications. Though non-diversity types will work well in many situations, the insurance provided by the diversity receiver against multipath problems is usually well worth the somewhat higher cost. Other receiver features that should be considered are: controls (power, output level, squelch, tuning), indicators (power, RF level, audio level, frequency), antennas (type, connectors), electrical outputs (connectors, impedance, line/microphone/headphone level, balanced/unbalanced). In some applications battery power may be required.

5) Determine the total number of systems to be used simultaneously. This should take into account future additions to the system: choosing a system type that can only accommodate a few frequencies may prove to be an eventual limitation. Of course, the total number should include any existing wireless microphone systems with which the new equipment must work.

6) Specify the geographic location in which these systems will be used. This information is necessary in the next step to avoid possible conflict with broadcast television frequencies. In the case of touring applications, this may include cities inside and outside of the US.

7) Coordinate frequencies for system compatibility and avoidance of known non-system sources. Consult the manufacturer or a knowledgeable professional about frequency selection and integration of the planned number of systems. This should be done even for single systems and must certainly be done for any multiple system installation to avoid potential interference problems. Frequency coordination includes the choice of operating band (VHF and/or UHF) and choice of the individual operating frequencies (for compatibility and avoidance of other transmissions). For fixed locations choose frequencies in unused TV channels. For touring applications, it may be necessary to carry additional systems on alternate frequencies, though this is only practical for a small number of channels. The preferred approach for touring is to use frequency-agile (tuneable) units to insure the required number of systems at all venues.

8) Specify accessory equipment as needed. This may include remote antennas (1/2 wave, 5/8 wave, directional), mounting hardware (brackets, ground-planes), antenna splitters (passive, active), and antenna cables (portable, fixed). These choices are dependent on operating frequencies and the individual application.

Crystal-Controlled vs. Frequency Synthesis

Crystal controlled wireless units can be designed with wide audio frequency response, low noise, low distortion, and relatively long battery life. They are the most cost-effective choice for fixed frequency applications involving a moderate number of simultaneous systems. One limitation inherent to a crystal controlled transmitter is the generation of spurious emissions due to output multiplier stages, though these can generally be kept to a minimum with careful design.

For tuneable systems, frequency synthesis is the most practical technique. The absence of spurious emissions from the transmitter also simplifies coordination of multiple systems. However, it is more difficult (and more expensive) to design equally low noise, low distortion frequency synthesized systems. A limitation inherent to the audio frequency response of this type of transmitter results from the use of a sharp lo-cut filter to prevent very low audio frequencies from interfering with the PLL control circuit. This places a lower limit on the audio frequency range that may be transmitted. Special techniques are required to achieve extended low frequency response in frequency synthesized systems.

Due to continuing improvements in design and manufacture of wireless products, most wireless microphone systems are now frequency-agile. The ability to tune away from interfering signals and the improved ease of multiple system frequency coordination are now available even in relatively low-cost products. In addition, automatic scanning and frequency selection are standard on many of these systems. For these reasons, frequency-agile systems are preferred for most applications, not only for touring but for fixed installations as well.

As in the choice of other wireless microphone system characteristics above, it is necessary to evaluate the application to determine which frequency generation method is preferable. Frequency synthesized systems must be considered when frequency agility is a primary requirement or if there are other included features that are desirable for the application.

Once the wireless microphone system(s) choice is made, careful setup and proper use are necessary to obtain the best performance.

System Setup: Transmitter

Transmitter setup first requires optimizing the source-to-transmitter interface. Sources include dynamic and condenser microphones, electronic musical instruments and general audio sources such as mixer outputs, playback devices, etc. The output signal of each of these sources is characterized by its level, impedance and



Figure 4-1: examples of transmitters
(left to right: handheld, bodypack, plug-on)

configuration (balanced or unbalanced). For sources such as condenser microphones, some type of power (phantom or bias) may be required.

The transmitter may be a bodypack, plug-on or handheld type and its input will also have a characteristic level, impedance and configuration (balanced or unbalanced). It may be capable of supplying power to the source. The interface can consist of some type of connector or it may be hard-wired, either internally or externally. (See Figure 4-1.)

The simplest interface is the handheld transmitter. This design should insure that the microphone element is already optimally integrated (electrically and mechanically) with the transmitter. The only choice involves systems that offer a selection of microphone elements. If each is equipped for proper interface the decision should be made based on the performance characteristics of the microphone element for the intended application.

The plug-on transmitter offers a range of interface possibilities. Mechanically, the 3-pin XLR type connector is standard but the electrical characteristics of the chosen microphone and transmitter combination must be considered. The input impedance of the transmitter should be higher than the microphone output impedance. All transmitters of this type will work with typical low-impedance dynamic microphones. If the transmitter input impedance is high enough (>10,000 ohms) a high impedance microphone may also be used. Most plug-on transmitters will work with either balanced or unbalanced microphone outputs.

Some plug-on transmitters are also capable of supplying "phantom power" to a condenser microphone. This is only possible with a balanced transmitter input and a balanced microphone output. Even then, the transmitter must supply at least the minimum phantom voltage

Selection and Operation of

WIRELESS

Microphone Systems

required by the microphone (usually between 11 and 52 volts DC). If less than the minimum is available, the condenser microphone performance may be compromised with less headroom or more distortion. This is not a concern with dynamic microphones (which do not require power) or with condenser microphones powered by an internal battery.

The bodypack transmitter presents the greatest range of possible interfaces. The simplest arrangement is the hard-wired lavalier or headset microphone. Again, it can usually be assumed that this design already provides the optimum interface for the components provided. If various hardwired microphone choices are offered, the selection should be based on the intended application.

Most bodypack transmitters are equipped with an input connector to allow the use of a variety of microphones and other input sources. (See Figure 4-2.) Microphones and input cables supplied by a manufacturer with a given wireless microphone system can be assumed to be compatible with that system. However, they may not be directly compatible with wireless microphone systems from other manufacturers. At a minimum, a connector change is often required. In many cases, additional circuitry or modifications to components will be necessary. A few combinations simply will not work.

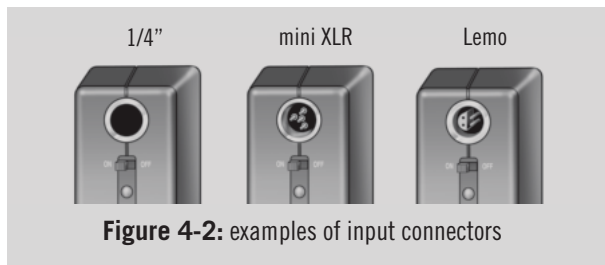

Figure 4-2: examples of input connectors

In order to determine the suitability of a particular microphone for use with a particular transmitter it is first necessary to determine the connector type(s) involved. Connectors include eighth-inch and quarter-inch phone jacks as well as a variety of multi-pin designs.

Next, the wiring of the microphone connector and the wiring of the transmitter connector must be compared. Unfortunately, there is no standard input connector, and further, the wiring scheme of the same connector may differ from one manufacturer to another. A quarter-inch input jack is usually wired unbalanced with the audio signal at the tip and shield on the sleeve. The typical multi-pin input on a body-pack transmitter has at least one pin for the audio signal and one pin for shield or ground. There may be other pins to provide "bias" (a DC voltage for a condenser microphone element) or to provide an alternate input impedance. Some transmitters have additional pins

to accept audio signals at different levels or to provide a combination audio + bias for certain condenser elements.

The electrical characteristics of the microphone and transmitter should then be compared: the output level of the microphone should be within the acceptable input level range of the transmitter and the output impedance of the microphone should be less than the input impedance of the transmitter. In addition, the input configuration of most bodypack units is unbalanced. Microphones intended for use with wireless are also invariably unbalanced, though a balanced output dynamic microphone can usually be accommodated with an adapter cable.

If the microphone has a condenser element and does not have its own power source then the transmitter must supply the required bias voltage. Most transmitters provide about 5 VDC, suitable for a typical electret condenser element, though some elements may require as much as 9 VDC. In this case, it is sometimes possible to modify the transmitter to provide the higher voltage.

Many condenser elements and associated transmitters use a two-conductor-plus-shield hookup in which the audio is carried on one conductor and the bias voltage on the other. A few condenser elements and some transmitters use a single-conductor-plus-shield arrangement in which the audio and bias voltage are carried on the same conductor. Interfacing a microphone of one scheme with a transmitter of the other may require modification of one or both components.

In general, for non-standard combinations, it is best to directly contact the manufacturer of the wireless microphone system and/or the manufacturer of the microphone to determine the compatibility of the desired components. They can provide the relevant specifications and can usually describe any limitations or necessary modifications.

Non-microphone sources include electronic musical instruments and possibly outputs from sound systems and playback devices. Though none of these sources require bias or phantom power their interface presents a much wider range of level and impedance than a typical microphone source.

Musical instruments such as electric guitars and basses can have output levels from a few millivolts (microphone level) for instruments with passive pickups to a few volts (line level) for those with active pickups. The transmitter must be capable of handling this dynamic range to avoid overmodulation or distortion.

Ordinary (passive) magnetic instrument pickups have a high output impedance and require a transmitter input impedance of about 1 Megohm to insure proper frequency response. Active (powered) pickups have fairly low output impedance and will work with almost any transmitter input impedance of 20,000 ohms or greater. Piezoelectric pickups

have very high output impedance and require a 1-5 Megohm transmitter input impedance to avoid loss of low frequencies.

Mixers and playback devices produce line level outputs. These sources typically have low-to-medium output impedance and may be balanced or unbalanced. They can sometimes be interfaced with a simple adapter cable. However, these high level input sources often require additional (external or internal) attenuation to prevent overload of the transmitter input, which is usually expecting a mic-level signal.

Once the source/transmitter interface has been optimized, control adjustment should be performed. The only control adjustment available on most transmitters is for input level or sensitivity. It consists of a small potentiometer and/or a switch. The control is often placed inside the battery compartment or in a recessed position to avoid accidental maladjustment. Some bodypack designs have separate level adjustments for microphone inputs and instrument inputs.

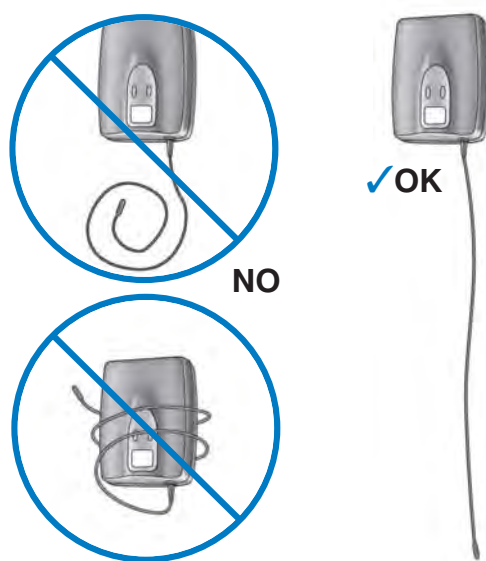

Figure 4-3: proper and improper antenna positions

The control(s) should be adjusted so that the loudest sound level (or highest instrument level) in actual use produces full modulation of the radio signal. This is usually determined by speaking or singing into the microphone (or playing the instrument) while observing audio level indicators on the receiver. Typically, an audio peak LED will indicate full (or nearly full) modulation. A few designs have peak indicators on the transmitters themselves. In systems that indicate peaks at less than full modulation, this LED may light fairly often. For systems that indicate full modulation, this should light only briefly at maximum input levels. In either case, sustained peak indication requires reducing input sensitivity or level to avoid audible distortion.

If the transmitter is equipped with a compander system (noise reduction) defeat switch make sure that it is set to the same mode as the receiver. The only situation in which this system would be defeated is with the use of a receiver that is not equipped with compander circuitry.

For tuneable transmitters, make sure that the transmitter is set to the same frequency as the receiver.

The last step in transmitter setup is placement. Placement of a handheld or plug-on system is essentially the same as for a wired microphone of the same type. The unit may be mounted on a stand, boom or fishpole with an appropriate stand adapter, or it may be handheld.

Bodypack transmitter placement is dependent on the particular application. If the input source is a microphone, such as a lavalier or headset, the bodypack is normally clipped to a belt or pants waistband. It may be attached in other ways as long as the antenna is allowed to extend freely. Insure that there is adequate access to the controls if necessary and that the connecting cable, if any, has enough length to permit the source and the transmitter to be located as desired. When the input is a musical instrument, it is often possible to attach the transmitter directly to the instrument or to its strap as in the case of an electric guitar.

For all types of transmitters, insure that the antenna is securely attached and positioned for maximum efficiency. Wire antennas should be fully extended. The hand should not cover external antennas on handheld transmitters. (See Figure 4-3.)

As much as possible, proper transmitter placement should avoid large metal objects and previously mentioned sources of RF such as digital devices, other wireless transmitters and mobile telephones. If an individual is using more than one wireless system at the same time, such as a wireless head-set and a wireless musical instrument, or is wearing a wireless personal monitor receiver, the devices should be kept as far apart as practical to minimize interaction.

System Setup: Receivers

Receiver setup involves two interfaces: antenna-to-receiver and receiver-to-sound system. (See Figure 4-4.)

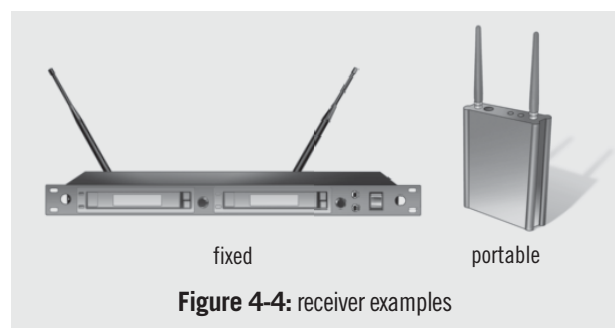

Figure 4-4: receiver examples

Audio Interface

Here we will discuss the sound system interface. Remember that the basic function of a wireless microphone system is to replace the connecting cable between the source and the sound system. In the typical

case, the output of the wireless receiver will resemble the output of the original source both electrically and physically. That is, most wireless microphone receivers have a balanced, low impedance, microphone level output, usually on a standard 3-pin XLR-type audio connector. This can be connected to a standard microphone input of a sound system using an ordinary balanced microphone cable. (See Figure 4-5.)

Some receivers, particularly those designed for use with electric instruments, may be equipped with a quarter-inch phone jack instead of (or in addition to) an XLR connector. Normally, this output is an unbalanced, low or medium impedance, microphone or instrument level signal. It can be directly connected to the input of an instrument amplifier using a standard shielded instrument cable.

In addition, a few receivers have line level outputs available. These can be connected to line or aux level inputs of sound systems equipped with similar types of input connectors.

If it is desired (or necessary) to connect one type of output to a different type of input a few possibilities should be considered. For a balanced XLR output to an unbalanced quarter-inch input an adapter which connects Pin 2 of the XLR to the tip of the phone plug and connects Pin 1 and Pin 3 of the XLR to the sleeve of the phone plug may be used. A similar adapter (with appropriate XLR connector) may be used to connect an unbalanced quarter-inch output to a balanced XLR input. Simple adapters of this type will usually work if the levels and impedances of the outputs and inputs are compatible.

In some cases simple adapters cannot be used due to significant impedance or level differences. In addition, the quarter-inch phone-to-XLR hookups just described (which cause the circuit to be unbalanced) can occasionally create audible hum problems due to ground loops between the receiver and the sound system. In either case, the use of a transformer may offer a solution. It can provide the proper transition between different impedances and between balanced and unbalanced circuits. The transformer also allows ground loops to be eliminated by lifting the shield connection at the source end of the balanced cable.

Finally, the presence of phantom power at the balanced microphone input of the sound system must be considered. If the receiver output is unbalanced, phantom

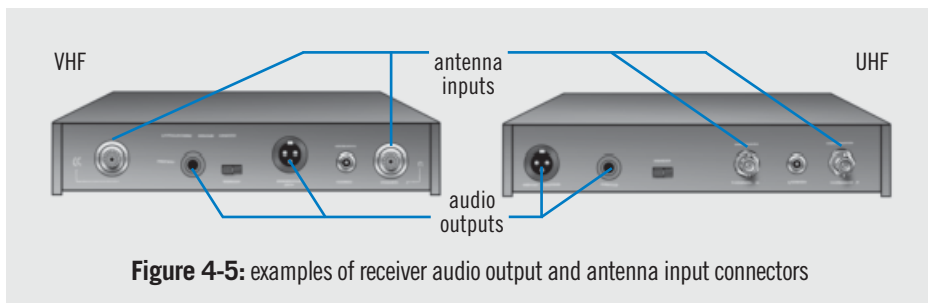

Figure 4-5: examples of receiver audio output and antenna input connectors

power may cause noise or distortion in the signal. Phantom power should be turned off at that input if possible. If not, a suitable transformer or an adapter with capacitors will block the voltage in the connecting path. However, if the receiver output is balanced, phantom power is usually not a problem though a manufacturer may specify the maximum voltage that the receiver can tolerate. A few receivers present a significant load to the phantom source. This can result in a lowering of the phantom voltage at other inputs on a mixer that has insufficient isolation of the phantom supply between inputs.

Once the receiver has been properly connected, then the sound system controls may be set. The first control adjustment on a receiver is the output level. This usually consists of a rotary pot and possibly a switch to select microphone or line level. The general procedure is to set the output level so that it is approximately the same as that of a wired source of the same type. This will provide normal gain structure in the rest of the sound system. Though microphone level is most common, line level can be appropriate for long cable runs or for driving line level devices such as equalizers, crossovers or power amplifiers. On most receivers, the audio level indicators are pre-volume control and are unaffected by receiver volume control settings. Use the indicators on subsequent equipment to gauge the actual output level.

Squelch Adjustment

Another receiver adjustment is the squelch control. Recall from the previous discussion that the function of the squelch circuit is to mute the audio output of the receiver when the transmitted signal is lost or becomes unacceptably noisy. Depending on the type of squelch system used (threshold squelch, noise squelch, tone-key squelch) the adjustment procedure will vary:

If a simple threshold squelch is used, adjustment may be required if the radio background noise level changes substantially. This would be indicated by loud "white noise" from the receiver output when the transmitter is turned off or drops out.

If noise squelch is used, no adjustment is normally necessary. Noise squelch mutes the receiver based on the signal-to-noise quality of the audio signal. The receiver

The threshold type squelch adjustment procedure is:

- 1) Turn the transmitter power off to eliminate the desired signal.
- 2) Turn on all associated equipment in nearby locations to create the "worst-case" signal condition.
- 3) Set the receiver volume control to minimum to avoid excessive noise in the sound system.
- 4) Turn the receiver power on.
- 5) Observe the RF and audio indicators on the receiver.
- 6) If the indicators are showing a no-signal condition the squelch setting may be left as-is.
- 7) If the indicators are showing a steady or intermittent signal-received condition increase the squelch control setting until a no-signal condition is indicated. Set the squelch control slightly past this point to provide a threshold margin.
- 8) If the no-signal condition cannot be achieved even with high squelch settings, it may be possible to find and eliminate the undesirable signal. Otherwise, it may be necessary to select a different operating frequency.
- 9) Turn the transmitter power on.
- 10) Make sure that the receiver indicates a signal-received condition with the transmitter at normal operating distance. Remember that high squelch settings reduce the operating distance.

will generally not produce noise in the absence of the transmitter signal. Setting the squelch above the default position will force the receiver to mute for mildly noisy signals, which will reduce the effective range somewhat. Setting the squelch below the default position will allow a noisier signal to be received, which may increase the effective range.

A receiver equipped with a tone-key squelch system also does not normally require adjustment. The receiver will only respond to a signal that contains the appropriate pilot "tone." The squelch may be varied from its default position with the same results as for the noise squelch system above.

Other receiver controls may include monitor (headphone) level, indicator selectors, channel selectors, etc. These may be set as desired for a particular application. If there is a compander (noise reduction) defeat switch, make sure that it is set to the same mode as the transmitter. Again, there is no reason to defeat the compander in the receiver unless the transmitter is not equipped with compander circuitry. If the receiver is tuneable, make sure that it is set to the same frequency as the transmitter. Some receivers are now capable of automatically scanning for a clear channel.

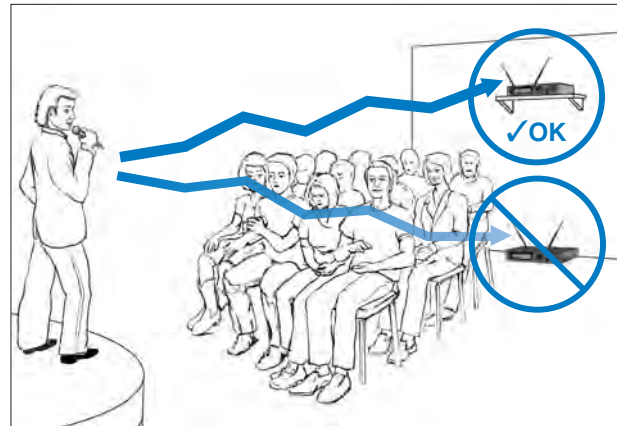

Figure 4-6: proper and improper antenna and receiver placement

Receiver Mounting and Placement

Proper placement of receivers involves both mechanical and electrical considerations. Mechanically, wireless receivers are usually designed to be used like other standard rackmount products. The electrical concerns are possible RF interference and possible hum or other electrical noise induced in the audio circuits. Receivers should be kept away from RF noise sources such as digital processors, computers and video equipment. They should also be separated from large AC sources such as power supplies for high current or high voltage equipment as well as lighting dimmers, fluorescent light ballasts and motors.

If wireless receivers are mounted in racks with other equipment it is best to place them with low-power analog devices nearby and potentially troublesome devices farther away or in a separate rack. In particular, if other wireless transmitting devices such as personal monitor transmitters or wireless intercom transmitters are used, it is strongly recommended that they be mounted in a different rack. Antennas from these transmitters should also be at a sufficient distance from receiver antennas. Obviously, if receivers are placed in metal racks or mounted between other metal devices it will be necessary to make sure that antenna function is not compromised.

System Setup: Receiver Antennas

Setup of receiver antennas involves first the antenna-to-receiver interface and then antenna placement. The simplest case is a receiver with the antenna(s) permanently attached. The antenna is typically a quarter-wave telescoping or possibly "rubber ducky" type. Receivers with non-detachable antennas should be placed on an open surface or shelf, in line-of-sight to the transmitter, for proper operation. They are often not suitable for rack mounting except perhaps as a single unit at the top of a rack and then only if the antennas are mounted on the front of the receiver or can project through the top of the rack.

A receiver with detachable antennas offers more versatility in setup. In most cases the antennas attach to the rear of the receiver. If the receiver is to be mounted in a metal rack the antennas must be brought to the outside of the rack. Some designs allow the antennas to be moved to the front of the receiver, while others provide an accessory panel for antenna relocation. Again, the receiver should be mounted high enough in the rack so that the antennas are essentially in the open.

Here are some general rules concerning setup and use of receiver antennas:

1) Maintain line-of-sight between the transmitter and receiver antennas as much as possible, particularly for UHF systems. Avoid metal objects, walls, and large numbers of people between the receiving antenna and its associated transmitter. Ideally, this means that receiving antennas should be in the same room as the transmitters and elevated above the audience or other obstructions. (See Figure 4-6.)

2) Locate the receiver antenna so that it is at a reasonable distance from the transmitter. A minimum distance of about 5 meters is recommended to avoid potential intermodulation products in the receiver. The maximum distance is not constant but is limited by transmitter power, intervening objects, interference, and receiver sensitivity. Ideally, it is better to have the antenna/receiver combination closer to the transmitter (and run a long audio cable) than to run a long antenna cable or to transmit over excessively long distances.

3) Use the proper type of receiver antenna. A quarter-wave antenna can be used if it is mounted directly to the receiver, to an antenna distribution device or to another panel, which acts as a ground-plane. If the antenna is to be located at a distance from the receiver, a half-wave antenna is recommended. This type has somewhat increased sensitivity over the quarter-wave and does not require a ground-plane. For installations requiring more distant antenna placement or in cases of strong interfering sources it may be necessary to use a directional (Yagi or log-periodic) antenna suitably aimed. Telescoping antennas should be extended to their proper length.

4) Select the correctly tuned receiver antenna(s). Most antennas have a finite bandwidth making them suitable for receivers operating only within a certain frequency band. When antenna distribution systems are used, receivers should be grouped with antennas of the appropriate frequency band as much as possible. For the VHF range: if the receiver frequencies span two adjacent antenna bands, the longer (lower frequency) antennas should be used. If the range spans all three antenna bands, one long antenna and one short antenna should be used (no middle length antenna). For the UHF range: receivers

should only be used with antennas of a matching range.

5) Locate diversity receiver antennas a suitable distance apart. For diversity reception the minimum separation for significant benefit is one-quarter wavelength (about 30 cm. for VHF and about 10 cm. for UHF). The effect improves somewhat up to a separation of about one wavelength. Diversity performance does not change substantially beyond this separation distance. However, in some large area applications, overall coverage may be improved by further separation. In these cases one or both antennas may be located to provide a shorter average distance to the transmitter(s) throughout the operating area.

6) Locate receiver antennas away from any suspected sources of interference. These include other receiver and transmitter antennas as well as sources mentioned earlier such as digital equipment, AC power equipment, etc.

7) Mount receiver antennas away from metal objects. Ideally, antennas should be in the open or else perpendicular to metal structures such as racks, grids, metal studs, etc. They should be at least one-quarter wavelength from any parallel metal structure. All antennas in a multiple system setup should be at least one-quarter wavelength apart.

8) Orient receiver antennas properly. A non-diversity receiver should generally have its antenna vertical. Diversity receivers can benefit from having antennas angled 45 degrees apart. Yagi and log-periodic types should be oriented with their transverse elements vertical.

9) Use the proper antenna cable for remotely locating receiver antennas. A minimum length of the appropriate low-loss cable equipped with suitable connectors will give the best results. Refer to the chart presented earlier. Because of increasing losses at higher frequencies, UHF systems may require special cables.

10) Use an antenna distribution system when possible. This will minimize the overall number of antennas and may reduce interference problems with multiple receivers. For two receivers a passive splitter may be used. For three or more receivers active splitters are strongly recommended. Verify proper antenna tuning as mentioned above. Antenna amplifiers are not usually necessary for VHF systems but may be required for UHF systems with long cable runs.

System Setup: Batteries

Always use fresh batteries of the correct type in the transmitter and/or receiver. Most manufacturers recommend only alkaline type batteries for proper operation. Alkaline batteries have a much higher power capacity, more favorable discharge rate and longer storage life than other types of single-use batteries such as carbon-zinc. Alkaline types will operate up to 10 times longer than so-called "heavy duty" non-alkaline cells. They are also far

less likely to cause corrosion problems if left in the unit. Consider bulk purchase of alkaline batteries to get the greatest economy: they have a shelf life of at least one year.

The battery condition should be determined before system use and checked periodically during use, if possible. Most transmitters are equipped with a battery status indicator of some kind that will at least indicate a go/no-go or some minimum operating time. Some units have a "fuel gauge" that can allow more precise indication of remaining battery life. A few models even have the capability of transmitting battery condition information to the receiver for remote monitoring.

Rechargeable batteries may be used in wireless microphones with some reservations. These reservations are dependent on the battery size and on the actual chemistry of the battery. The conventional rechargeable battery uses a Ni-Cad (nickel-cadmium) cell or Ni-Mh (nickel-metal-hydride) cell. The voltage of an individual Ni-Cad or Ni-Mh cell is 1.2 volts rather than the 1.5 volts of an alkaline cell. This is a 20% lower starting voltage per cell. For systems using AA or AAA size batteries, this lower starting voltage may not be an issue because most transmitters using these battery sizes have internal voltage regulators that can compensate. High capacity Ni-Mh single cell (AA or AAA) batteries are available with operating times that are comparable to single cell alkaline types.

However, the standard alkaline 9-volt battery is made up of six cells in series, which yields an initial voltage of at least 9 volts. Typical continuous operating time for a 9-volt alkaline battery in a wireless microphone is about eight hours. The least expensive "9-volt size" rechargeable also has six cells, giving it an initial voltage of only 7.2 volts. When combined with its lower power capacity the operating time may be less than 1/20 of an alkaline, only about 15 minutes in some units. The "better" 9-volt size rechargeable has seven cells (8.4 volts initial), but still has significantly less power capacity than an alkaline. Operating time for these types may be as little as two hours compared to eight hours for an alkaline 9-volt battery (See Figure 4-7).

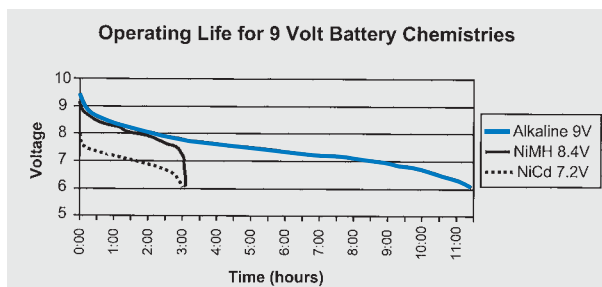

Figure 4-7: alkaline vs. rechargeable batteries

It is possible to obtain high performance 9-volt size Ni-Mh batteries that approach the power capacity of an alkaline. These may offer up to six hours of operation.

A battery chemistry that exceeds alkaline capacity is the lithium-ion (Li-on) or lithium-polymer (Li-polymer) type. Not only do these batteries offer higher power density than alkalines, they offer better charging characteristics and longer service life than Ni-Cad or Ni-Mh types. In addition, custom versions of the Li-on contain an integrated circuit that monitors both the short term and long term state of the battery. This allows extremely accurate battery voltage measurement as well as maximum battery life. The Li-on battery is becoming the standard rechargeable chemistry for many professional applications.

If it is decided to use rechargeable batteries, battery management is very important. For systems in daily service a minimum of two batteries per unit is recommended due to the charging time: one charging, and one in use. In addition, Ni-Cad batteries must periodically be completely cycled to get maximum service life and avoid developing a short discharge "memory effect." Generally, Ni-Mh and Li-on types do not exhibit memory effect. However, for maximum performance from any rechargeable battery it is necessary to use a high-quality charger that is designed for the specific battery type. Improper charging can impair or even damage rechargeable batteries prematurely.

Ultimately, the long-term potential savings in battery cost must be weighed against the expected operating time, initial investment and ongoing maintenance requirements for rechargeable batteries.

System Checkout and Operation

Good practice with any wireless microphone system calls for a checkout of the system ahead of performance time. As suggested in the squelch adjustment section this should be done with all associated production equipment also on. This may reveal potential problems that are not apparent in a wireless-system-only test.

It should be noted in Step 3 (on pg. 42) that certain combinations of active transmitters and receivers might indicate pickup of an individual transmitter by more than one receiver. However, in Step 7 (on pg. 42), when all transmitters are active, each should be picked up by just its intended receiver. Unless there is audible interference when all transmitters are on this should not pose a problem, since a receiver should not normally be turned up when its own transmitter is not active. Once the wireless microphone systems have passed this checkout there are a few recommendations to achieve successful operation during the performance:

Pre-Show Checkout:

- 1) Verify good batteries in all transmitters.
- 2) Turn on all receivers (without transmitters) and all antenna distribution equipment. All receivers should show little or no RF activity.
- 3) Turn on individual transmitters one at a time to verify activation of proper receiver. Transmitters should all be at a comparable distance (at least 5 meters) from receiving antennas. Off-channel receivers should show little or no RF activity.
- 4) Turn on all transmitters (with receivers) to verify activation of all receivers. Transmitters should all be at a comparable distance (at least 5 meters) from receiving antennas and at least 1 meter from each other.
- 5) Perform a stationary listening test with each individual system one at a time to verify proper audio level settings.
- 6) Perform a listening test around the performance area with each individual system one at a time to verify no dropouts.
- 7) Perform a listening test around the performance area with each individual system while all systems are on to verify no audible interference or dropouts.

Show Operation:

- 1) Again, verify good batteries in all transmitters.
- 2) Receivers should be muted until transmitters are on.
- 3) Do not activate unneeded transmitters or their associated receivers.
- 4) Once the system is on, use the "mute" or "microphone" switch to turn off the audio if necessary, not power switch.
(This is not a concern for tone-key squelch systems.)
- 5) Do not bring up the sound system audio level for any receiver that does not have an active transmitter.
- 6) Maintain line-of-sight from transmitter antennas to receiver antennas.
- 7) Maintain transmitter-to-receiver antenna distance of at least 5 meters.
- 8) Maintain transmitter-to-transmitter distance of at least 1 meter if possible.
- 9) Operate transmitters in the same general performance area.
- 10) At the end of the event mute receiver outputs before turning off transmitters.

Computer-Controlled Wireless Systems

It was noted in the digital wireless selection that digital control circuits are now common in wireless systems, particularly frequency-agile designs. Various transmitter and receiver functions are handled by embedded microprocessors. Display information is also digitally generated. One result of these internal technologies is the possibility of external monitoring and control of wireless systems.

Although this goal could be achieved with proprietary controls and displays, the most common wireless system interface device is the personal computer. By using such a universal platform it is possible to monitor and control large-scale wireless installations from both local and remote points. Hookup is usually through either USB or Ethernet connections.

Typical monitor capabilities include battery condition, RF signal strength, audio level and diversity status. Typical receiver control functions include frequency selection, squelch level set, and alphanumeric channel naming.

In addition, some systems can automate the selection of appropriate operating frequencies without prior knowledge of the RF environment.

Such systems have a set-up mode during which the receiver functions as an automatic radio scanner to find open channels. This scan-mode can be under the control of an onboard microprocessor in an individual receiver or externally controlled by a computer. The receiver can also be made to function as a simple RF spectrum analyzer for interference problems or as an RF level recorder for uncovering possible antenna problems in a pre-show walk-through.

Finally, computer data management capability permits creating and recalling "scenes" or setups for touring, rentals, and other temporary applications, as well as logging of wireless system performance. All of this information can be reviewed as

needed for troubleshooting or maintenance. Presently, computer control can assist in setup and operation of even moderate-sized wireless rigs and is the only practical way of integrating very large wireless installations.



Figure 4-8: Shure Axient Wireless System

"Intelligent" Wireless Systems

An extension of wireless system control is the ability to communicate with transmitters through a secondary radio link. These "back-channel" techniques typically operate in the 2.4 GHz range in a manner that is somewhat similar to Wi-Fi as a two-way data link. This gives the user the ability to control the transmitter remotely. Audio gain, transmitter power, and even transmit frequency can be adjusted at a distance either from an associated receiver or other outboard control device such as a computer.

In addition, receivers have been developed that can recognize an interfering signal. When combined with remote control of transmitters, it is now possible for such a receiver to automatically retune itself and the associated transmitter to a clear frequency with almost no interruption of the audio signal.

When combined with appropriate equipment, such a system can find and set all channels to a compatible frequency set and then continue to monitor and change frequencies as needed during an event to maintain continuous operation even in very dynamic RF environments.

Troubleshooting Wireless Microphone Systems

Even when wireless microphone systems appear to be properly selected and set up, problems may arise in actual use. While it is not practical here to offer comprehensive solutions for all possible situations some general guidelines are suggested.

Though problems with wireless microphone systems eventually show up as audible effects these effects can be symptoms of audio and/or radio problems. The object of troubleshooting in either situation is first to identify the source of the problem and second to reduce or eliminate the problem.

The following abbreviations are used in these charts:

AF-audio frequency, RF-radio frequency, RFI-radio frequency interference, TX-transmitter, RCV-receiver

A common symptom in multiple system operation is apparent activation of two receivers by a single transmitter. This can be due to one of several causes: operating frequencies the same or too close, crystal harmonics, transmitter at the image frequency of the second receiver, IM with an unknown source, etc. If activating the second transmitter results in proper operation of both systems this effect can usually be ignored. Recommended operating procedure is to turn up a receiver only when its transmitter is active. If it is desired to allow open receivers without transmitters, readjusting the squelch settings may suffice. Otherwise the operating frequencies may have to be changed.

Troubleshooting Guide

Conditions: TX on, RCV on, single system

Symptom	TX - RCV Distance	Possible cause	Action
No AF signal and no RF signal	any	low TX battery voltage	replace battery
No AF signal and no RF signal	any	TX and RCV tuned to different frequencies	retune one or both units
No AF signal and no RF signal	average	multipath dropout	use diversity RCV or reposition TX and/or RCV
No AF signal and no RF signal	long	out of range	move TX closer to RCV
No AF signal but normal RF signal	any	TX muted	un-mute TX
No AF signal but normal RF signal	any	microphone or other input source	check input source
Distortion with no AF peak indication	any	low TX battery voltage	replace battery
Distortion with AF peak indication	any	excessive TX input level	decrease source level or TX input level
Distortion with AF peak indication in subsequent equipment	any	excessive RCV output level	decrease RCV output level
Noise with low AF signal and normal RF signal	any	insufficient TX input level	increase source level or TX input level
Noise with low AF signal and normal RF signal	any	strong RFI	identify source and eliminate, or change frequency of wireless microphone system
Noise with normal AF signal and low RF signal	average	moderate RFI	increase squelch setting until RCV mutes
Noise with normal AF and RF signals	any	very strong RFI	identify source and eliminate, or change frequency of wireless microphone system
Intermittent AF signal and low RF signal	long	out of range	move TX closer to RCV
Intermittent AF signal and low RF signal	long	insufficient antenna gain	use higher gain antenna
Intermittent AF signal and low RF signal	long	excessive antenna cable loss	use low loss cable and/or less cable
Intermittent AF and RF signals	average	multipath interference	use diversity RCV or reposition TX and/or RCV
Intermittent AF and RF signals	average	obstructions in signal path and/or RCV	remove obstructions or reposition TX
Intermittent AF and RF signals	average	squelch set too high	decrease squelch setting
Intermittent AF and RF signals	average	very strong RFI	identify source and eliminate, or change frequency of wireless microphone system

When multiple systems are in use some additional problems can occur due to interaction between the systems. Turning individual systems on and off and trying systems in different combinations can help to pinpoint the cause. However, this can become much more difficult as the number of systems increases.

Following are some multiple system troubleshooting suggestions for symptoms observed when all systems are active.

Conditions: TX on, RCV on, multiple systems

Symptom	Distance	Possible cause	Action
Distortion on two (or more) systems with no AF peak indication	any	units on same frequency	change frequencies
Distortion on one (or more) systems with no AF peak indication	TX-TX short	TX + TX intermod	change frequencies
Distortion on one (or more) systems with no AF peak indication	TX-TX short	TX + TX intermod	increase TX to TX distance
Distortion on one (or more) systems with no AF peak indication	TX-RCV short	TX + TX + RCV intermod	change frequencies
Distortion on one (or more) systems with no AF peak indication	TX-RCV short	TX + TX + RCV intermod	increase TX to RCV distance

CHAPTER FIVE

APPLICATION NOTES

Following are some suggestions on wireless microphone system selection and use for some specific applications. Each section gives typical choices and setup for microphones, transmitters and receivers as well as a few operating tips.

Presenters

The most common wireless choice for presenters has been the lavalier/bodypack system, which allows hands-free use for a single speaking voice. However, the traditional lavalier microphone is often being replaced by a small headworn microphone because of its much better acoustic performance.



In either case, the microphone is connected to a bodypack transmitter and the combination is worn by the presenter. The receiver is located in a fixed position.

The bodypack transmitter is generally worn at the waistband or belt. It should be located so that the antenna can be freely extended and so that the controls can be reached easily. Transmitter gain should be adjusted to provide suitable level for the particular presenter.

The receiver should be located so that its antennas are line of sight to the transmitter and at a suitable distance, preferably at least 5 meters. Once the receiver is connected to the sound system the output level and squelch should be adjusted according to the previous recommendations.

The most important factor in achieving good sound quality and adequate gain-before-feedback with a lavalier system is microphone choice and placement. A high quality microphone placed as close as practical to the wearers' mouth is the best starting point. An omnidirectional lavalier microphone should be attached to the presenter on a tie, lapel or other location within 8-10 inches of the mouth for best pickup.

The headworn microphone has a significant advantage because of its much closer placement to the mouth. Compared to a lavalier microphone at 8 inches from the mouth, a headworn type placed within one inch of the mouth will have 18dB better gain-before-feedback. In addition, because the microphone is always at the same distance from the mouth, there is no volume change or tonal change as the presenter's head moves in any direction.

In situations of limited gain-before-feedback or high ambient noise levels a unidirectional microphone may be used.

This type should be located like the omnidirectional type but it must also be aimed at the presenter's mouth. The user should be aware that unidirectional types are much more sensitive to wind noise and breath blasts (k's, t's, d's, etc.) as well as noise from clothing rubbing against the microphone or cable. Unidirectional microphones should always be used with a windscreen and mounted in a way to reduce direct mechanical contact with clothing or jewelry. Again, the headworn type has an advantage because the microphone itself is not in contact with clothing or other articles.

Finally, it should be noted that the unidirectional gain-before-feedback improvement is typically only 6-8dB. Thus, an omnidirectional headworn microphone will still have at least a 11-12dB advantage in gain-before-feedback over a unidirectional lavalier type. This is sufficient to allow the use of omnidirectional headworn microphones in all but the most severe feedback environments. A unidirectional headworn microphone can perform nearly identically to a unidirectional handheld type and substantially better than any lavalier type in this case.

Musical Instruments

The most appropriate choice for an instrument wireless application is a bodypack system, which will accept the audio signal from various instrument sources. The receiver can be a diversity design for highest performance or non-diversity for economy applications and is located in a fixed position.

The transmitter can often be attached to the instrument itself or to the instrument strap. In any case it should be located to avoid interfering with the player but with its controls accessible. Instrument sources include electric guitars and basses as well as acoustic instruments such as saxophones and trumpets. Electric sources can usually connect directly to a transmitter while acoustic sources require a microphone or other transducer.

Receivers for instrument systems are connected to an instrument amplifier for electric guitars and basses or to a mixer input for acoustic instruments, which are not otherwise amplified. Be aware of the potential for interference from digital effects processors in the vicinity of the amplifier or at the mixer position. Connections should be well-shielded and secure. Again the usual distance and line-of-sight considerations apply.



Selection and Operation of **WIRELESS** Microphone Systems

The most important factor in the performance of an instrument system is the interface between the instrument and the transmitter. The signals from electric instruments fitted with magnetic pickups are generally comparable to microphone signals, though the levels and impedances may be somewhat higher. Other transducers such as piezo-electric types have output signals that also are similar to microphone signals but again may have higher levels and substantially higher impedances. With any of these sources care should be taken to insure that there is compatibility with the transmitter input in regard to level, impedance and connector type.

Occasionally it is found that certain wireless microphone systems do not initially work well with certain instruments. Symptoms may include poor frequency response, distortion or noise. In most cases this can be traced to an impedance or level mismatch between the two. Frequency response changes are most often due to impedance problems. Make sure that the transmitter has sufficiently high input impedance. Distortion is usually due to excessive input level to the transmitter. Instruments with active circuitry (battery powered preamps) often have very high output levels which may need to be attenuated for some transmitters. They may also suffer from RFI caused by the wireless microphone system. This may be reduced by the addition of RF filters in the instrument.

A common type of noise that is heard in wireless microphone systems is often called modulation noise. This is a low-level hiss, which accompanies the actual instrument sound. Though it is usually masked by the instrument sound certain factors may make it more pronounced. These include low audio signal levels, low RF signal levels and high RF noise levels. Modulation noise can be most noticeable when the wireless microphone system is connected to a high gain instrument amplifier with boosted high frequencies and distortion circuits engaged. The apparent level of modulation noise can be reduced by setting the transmitter gain as high as possible (without causing distortion), maintaining adequate RF signal level and avoiding sources of RF noise.

Some electric guitars and basses used with wireless microphone systems may also exhibit intermittent noise when their control pots are moved to or from the endpoints of their rotation (full-on or full-off). This is due to metal-to-metal contact, which occurs at these points in certain potentiometer designs. A different type of pot may need to be substituted.

Microphones for acoustic instruments may be omnidirectional and are usually condenser types. Microphone selection and placement for acoustic instruments is a subjective process that may involve a certain amount of trial and error. See the references in the bibliography for suggestions.

It is advised to consult the manufacturer of the wireless equipment and/or the manufacturer(s) of the instruments, microphones and transducers if problems persist. They may have details of suggested modifications for one or both units.

One wireless benefit of interest to guitar players is the elimination of the potential shock hazard created between a wired electric guitar and a wired microphone. Once the hardwire connection between either the guitar and amplifier or between the microphone and the PA system is removed the polarity of the guitar amp is of no consequence.

Vocalists

The usual choice for vocalists is a handheld wireless microphone system for close pickup of the singing voice. It consists of a suitable vocal microphone element attached to a handheld transmitter used with a fixed receiver.



The microphone/transmitter may be handheld or mounted on a microphone stand. Microphone technique is essentially the same as for a wired microphone: close placement gives the most gain-before-feedback, the least ambient noise pickup and the most proximity effect. An accessory pop filter may be used if wind or breath blast is a problem. If the transmitter is equipped with an external antenna avoid placing the hand around it. If the transmitter has externally accessible controls it may be useful to conceal them with a sleeve or tape to avoid accidental switching during a performance. Some transmitters can be set to lock out the controls. Battery condition should be checked prior to this if the indicator will be covered. Transmitter gain should be adjusted for the particular vocalist at performance levels.

A popular option for vocalists who require hands-free operation is the unidirectional headworn microphone. It can have gain-before-feedback performance equivalent to a handheld and similar sound quality as well. The only operational difference is that the vocalist cannot “work” the microphone by changing its distance from the mouth. Thus, vocal dynamics need to be adjusted with the singer’s vocal technique rather than by microphone technique.

The receiver should be located at a suitable distance and in line of sight to the transmitter. Since this is often at the mixer position, check for possible interference from nearby digital signal processors. Again antenna and audio connections should be well-shielded and secure.

Selection and Operation of

WIRELESS

Microphone Systems

The primary considerations for sound quality in a hand-held wireless microphone system is the microphone element and its proper integration with the transmitter. The choice of element for a wireless microphone system would be made according to the same criteria as for a wired microphone. Ideally the wireless version of a microphone will sound identical to the wired version. Ultimately this is up to the manufacturer of the wireless microphone system. For this reason it is highly recommended to compare the performance of the proposed wireless microphone system to its wired counterpart to make sure that any differences in sound quality or directionality are minimal.

Aerobic/Dance Instruction



Aerobic and dance applications most often require bodypack wireless microphone systems to allow hands-free use by the instructor. The microphone is most often a headworn type, with a unidirectional element. This will give the best results for feedback control and overall sound quality.

A lavalier microphone may be used if gain-before-feedback is not a problem but it will not have the same sound quality as a headworn type. The receiver may be diversity or non-diversity depending on the performance level required and is located in a fixed position.

The transmitter is worn at the waist and must be securely attached since the user is generally quite active. The antenna should be freely extended and the controls accessibly located. Gain should be adjusted for the individual under actual use conditions.

The receiver should be located with the usual regard to distance and line of sight. In addition it should be out of the way of moving bodies and feet. Since these systems are often set up and taken down the connections should be regularly checked.

The primary criterion for aerobic/dance systems is reliability under extremely active conditions. These conditions include vibration, impact, heat, humidity and various bodily fluids! The basic system must certainly be durable but there are some additional steps that can be taken to improve long-term reliability. An accessory belt or pouch made of neoprene can protect the transmitter from mechanical damage as well as perspiration. It also provides a pad between the wearer and the transmitter to improve comfort and allows the transmitter to be easily repositioned if the instructor is doing floor exercises, etc. A design that covers the controls and/or connectors will further resist corrosion damage at these points of entry.

Microphone cable life can be prolonged by routing the cable to avoid extreme flexing or pull. Allow slack at the headband and at the point of entry to the transmitter. A side entry design provides more strain relief and allows for a drip loop in the cable to prevent perspiration from flowing down the cable into the connector. If an adjustable headband is used it should be adjusted only as often as necessary to maintain adequate stability.

The microphone element can be somewhat protected by using a foam windscreen. Periodically remove the windscreen, sponge it in warm soapy water, rinse and let dry. Replace when it shows signs of wear. However, even with these precautions the microphone and cable assembly in such a system should probably be considered a consumable item.

Theater

Theatrical applications also generally call for lavalier/bodypack wireless microphone systems. The microphone and transmitter are worn by the performer while the receiver is in a fixed location. Theater combines aspects of presenter, vocalist, and aerobic/dance applications with additional unique requirements.

In current theater practice the lavalier microphone is often concealed somewhere on the head of the performer: just in front of the ear, on the forehead, in the hair or beard, etc. In some cases it is concealed in some part of the costume such as a hat or high collar.



The intent is always to get the microphone as close to the performer's mouth as possible without being visible. The close placement maximizes gain-before feedback and minimizes noise and acoustic interference. Miniature omnidirectional types are used almost exclusively, but they must be of high quality for both speech and singing. Avoid obstructing the ports on microphones with makeup or adhesives.

Headworn microphones have become much more common in theatrical applications, particularly for high-sound-level musical theater. Again, the benefits of very high gain-before-feedback, high signal-to-noise ratio, and consistent microphone-to-mouth distance make the headworn type an excellent choice in this setting.

Transmitters are also concealed in or under costumes and are often subject to an even more severe environment than the aerobic/dance situation. Special packs and bindings are available to attach the transmitter to various parts of the body. Latex covers are sometimes used to protect transmitters from sweat. Routing microphone cables and antennas and still allowing quick costume changes presents a serious challenge. Normal wear and tear on

Selection and Operation of WIRELESS Microphone Systems

cables and connectors will take a rapid toll on anything but the most reliable microphones and transmitters.

Receivers for theatrical applications are not unique but they must be of high quality to allow multiple system use without interference. It is not unusual to use as many as 30 simultaneous wireless microphone systems in a professional musical theater production. This number can only be handled with systems operating in the UHF range. 10 to 12 systems is the practical limit at VHF frequencies. In addition, separate antennas and antenna distribution systems are necessary for any installation involving a large number of systems.

Though small-scale theater applications can be done with a moderate investment in planning and equipment, large-scale productions usually require professional coordination of wireless microphone systems to achieve successful results. This becomes an absolute necessity for a touring production.

Worship

Worship services may include presenter, vocalist and instrument applications. While wireless vocal and instrument use is essentially the same as outlined in the preceding sections, the presenter function may be somewhat different. Microphone, transmitter and receiver selection are as before but placement of the components may require extra consideration.



In particular, proper location of the lavalier microphone and/or transmitter may pose problems because of robes or vestments. It is still necessary to position the microphone as close as practical to the user's mouth for best results. Different methods of attachment may be necessary. Access to transmitter controls can also be problematic. Use of accessory microphone mute switches similar to those worn by sports referees can be the answer. Though an omnidirectional type microphone is easier to use, a unidirectional model may be chosen to allow more gain-before-feedback. In this case pop sensitivity and mechanical noise should be taken into account. Again it is very important to adjust the transmitter level for the individuals' voice under actual conditions.

Note that headworn microphones are becoming more acceptable for worship applications. They provide the highest gain-before-feedback in a hands-free type.

Because most worship services involve both wired lectern microphones and wireless lavalier microphones it often happens that the person wearing the wireless is also speaking at the lectern. If the voice is picked up by both microphones an acoustic phenomenon known as "comb filtering" occurs which creates a hollow, unnatural sound. The solution is to turn down one of the two microphones whenever they are within one or two feet of each other.

In most cases it will be less noticeable to turn down the lectern microphone when the wireless wearer approaches it.

Proper frequency selection is necessary for any worship application. Since a fixed location is the norm, unused TV channel frequencies are the best recommendation, not "traveling" frequencies. The simultaneous use of other wireless microphone systems by vocalists and musicians during the service must be considered as well. In addition, wireless microphone systems at other churches or facilities within 1000 feet of the site should be included in any program for frequency coordination.

Finally, receivers should be located and adjusted according to the suggestions made earlier. Even with proper squelch settings, though, it is very strongly recommended to turn off or turn down the outputs of any receivers that do not have an active transmitter. This will avoid noise from random RF interference being heard in the sound system.

Bingo

Wireless microphones are common in large-scale bingo halls. Though the caller is typically in a fixed location and uses a hardwired microphone, the checkers must be able to move about the hall in order to verify the cards. Handheld systems are the usual choice but bodypack systems with either headworn or lavalier microphones are also used. Receivers are in fixed locations.

Selection and operation of wireless for this application is straightforward though often strongly influenced by budget. In particular, it is often requested that a single receiver be used for multiple transmitters on the same frequency since only a single checker need be on the air at any one time. While this is technically possible it becomes difficult in practice for two reasons: failure to turn off transmitters when not needed and noise that occurs when transmitters are switched on and off. As indicated previously, simultaneous operation of more than one transmitter on the same frequency creates severe interference. In addition, some amount of switching noise is inevitable except in tone-key squelch systems.

Transmitters should be muted when not being used, but power should remain on to eliminate possibility of noise. If it is desired to turn the checker wireless transmitters off during the event, make sure that squelch levels are adjusted properly. Ideally, the corresponding receiver(s) should be turned down until needed. Tone-key squelch systems are useful in this application to allow transmitters to be turned on and off without noise.

Receivers and antennas should be located properly for coverage of the intended area. The usual suggestions concerning frequency selection apply. In particular, unused TV channel frequencies are recommended since bingo systems are generally in fixed locations.

Selection and Operation of

WIRELESS

Microphone Systems

Film/Videography

Film and videography applications usually call for lavalier/bodypack wireless microphone systems to minimize the visibility of the microphone. Handheld transmitters may also be used when visual appearance is not an issue. However, the receivers may be either fixed or portable.



A common choice is a camera-mounted receiver used with a camcorder. Microphone/transmitter selection and placement are as outlined in other sections. Directional microphones are useful to control ambient noise. Placement can be consistent with visual requirements but should be positioned as close as practical to the sound source. The overall audio quality is largely determined by microphone selection and placement.

An important area in the use of wireless microphone systems with video and film equipment is the electrical interface between them. The interface is specified in terms of level, impedance, configuration (balanced/unbalanced) and connector. While the output characteristics of wireless receivers are well specified and fairly standard, the audio input characteristics of video equipment are often unspecified and unique. This is especially true for consumer video camcorders. Professional video units are normally designed with standard professional audio inputs.

Most camcorders that have a built-in microphone also have an input jack for an external microphone. This is usually a 1/8" mini phone jack. If the wireless receiver is equipped with a microphone-level 1/4" phone jack output a simple adapter cable will generally suffice. If the receiver only has an XLR-type output some additional concerns arise. An adapter cable or transformer can be used as described in the receiver setup section above.

Stereo camcorders often use an 1/8" stereo (tip-ring-sleeve) external microphone jack. To deliver a monophonic wireless signal to both the left and right audio channels a mono-to-stereo adapter must be inserted at the input jack. Some camera-mount receivers include a special output cable designed to work in either mono or stereo inputs.

Certain camcorder microphone inputs also supply a DC bias voltage for condenser microphones. In this case a transformer or blocking capacitor may be required to isolate the output of the wireless receiver from the DC. Consult the camcorder literature or manufacturer for details.

Camcorders that do not have manual audio level controls are always equipped with an automatic gain control

(AGC). Its function is to maintain a constant audio recording level by increasing the gain for weak signals and decreasing the gain for strong signals. This circuit is generally not defeatable. When using the built-in microphone most direct sound sources are at a significant distance. At the microphone the overall variation between direct sound level and background sound level is not very large.

Close-talked microphones, either handheld or lavalier, present a much stronger signal relative to the background sound level. With these devices the AGC will operate at high gain when only background sound is present and will quickly reduce gain when a strong close-talk signal occurs. This will result in audible "pumping" of the background noise level. The same effect is typically heard in live sports broadcasts: the crowd noise is quickly suppressed when the announcer speaks and slowly returns when the announcer is silent. Unfortunately, if the AGC is not defeatable there is no convenient way to eliminate this effect. Operating the wireless microphone system at very low levels can force the AGC to operate at full gain but this will result in noisy audio tracks.

Frequency selection for film/videography should be done according to the guidelines already presented. One additional source of potential interference is the video equipment itself since it contains digital and RF circuitry. Listen for audible effects from both the transmitter and from the receiver when they are used close to the camera and/or video recorders.

Broadcast

Broadcast applications may require handheld, plug-on and/or bodypack wireless microphone systems. To interview random subjects most field reporters and roving talk show hosts prefer a handheld or plug-on transmitter for maximum mobility and control. Bodypack systems are used to pick up a single talent when a handheld type would be cumbersome. Receivers may be in a fixed location for studio use or may be portable for field use.

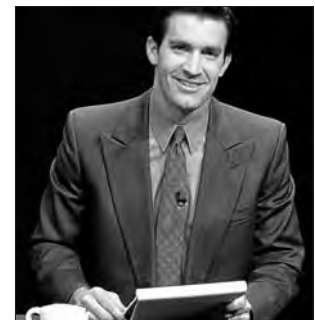

Omnidirectional microphones are the preferred choice for situations where ambient noise is not excessive. This allows more flexibility in placement and orientation as well as reduced sensitivity to wind and handling noise. When ambient noise is a factor or in a setup where feedback is a possibility a unidirectional microphone may be necessary. Microphones with good sound quality and durability are a must.

Lavaliere microphones will require a bodypack transmitter. If a desired handheld microphone model is available in a wireless version it can be used directly. Since most handheld transmitters use unidirectional microphone elements a plug-on transmitter may be necessary for use with handheld omnidirectional microphones or other wired hand-held models.

Even for portable or camera-mount use a diversity receiver is standard choice for professional broadcast applications. Antenna location should be well planned, especially when used in a studio environment with lighting grids and other large metal structures. Receivers should be located away from lighting controllers, digital audio equipment and video equipment that may produce interference. Balanced audio lines are also standard procedure.

Receivers used in remote trucks face interference not only from nearby audio and video equipment but they may also be subject to interference from two-way radio systems and remote-to-studio transmitters operating on VHF or UHF frequencies. Two-way transceivers should not be operated close to wireless transmitters or receivers. The wireless microphone system receivers should also be located well away from remote link transmitters. In addition, both the wireless microphone system antennas and the remote link antennas should be properly installed for minimum interference with each other.

Frequency selection for broadcast involves the same considerations as in other applications for studio use. In ENG (Electronic News Gathering) or EFP (Electronic Field Production) situations the additional factors of nearby remote transmitters and the possibility of wireless microphone systems in use by other broadcast crews must be taken into account. In a local area it is sometimes possible to coordinate frequencies between different stations ahead of time to reduce the likelihood of frequency conflict at a news site. Specifying high quality frequency-agile wireless equipment will further minimize interference problems.

Point-to-Point Wireless Introduction

Often it is desirable (or even mandatory) to send an audio signal from one fixed location to another fixed location without wires. This is termed "point-to-point" wireless. In some cases this may involve a single transmit location and multiple receive locations, referred to as "point-to-multi-point" wireless. Possible applications include remote speaker/amplifier locations, remote recording/broadcast operations, and one-way communication links. Potentially this could be accomplished either by optical transmission or by radio frequency transmission.

Optical methods are inherently limited to line-of-sight conditions. The use of conventional (non-directional) infrared transmission is limited by ambient light levels vs. practical infrared power levels. Modulated laser transmission (highly directional) is another optical possibility but available systems are primarily geared to high-speed data/video transmission and are not widely (or affordably) distributed.

Low-power radio transmission systems, on the other hand, are both widely available and relatively affordable. For radio signals, line-of-sight conditions are desirable but they are not strictly required. In addition, point-to-multi-point is more easily accomplished with a single radio transmitter.

General requirements for point-to-point wireless include:

- High fidelity audio
- Line level in and line level out
- AC-power capability for both transmitter and receiver
- "Sufficient" transmission distance

Most radio communication products such as wireless intercoms, two-way radios, and mobile phones are unsuitable due to lack of audio fidelity. However, two common high-fidelity radio products that can be used in a point-to-point application are the wireless microphone system and the wireless in-ear monitor system. Each of these has slightly different concerns/advantages in performance and in setup.

Using wireless microphones for point-to-point

A bodypack wireless system can fulfill the requirements above with two modifications. (See Figure 5-1.) First, though many receivers have line level outputs, few transmitters are capable of accepting a line level input signal. This can be accomplished by using an external pad or attenuator at the transmitter input. Second, though most receivers run on AC power, transmitters are battery-only devices. Using a suitable external DC power supply can provide the necessary AC capability for the transmitter.

Once the input signal is sufficiently attenuated and power is provided, the bodypack transmitter should be located to provide the best line-of-sight to the receiver. This usually involves securing the pack to a pole or some other elevated structure. If wet weather is a factor, the transmitter can be protected by a "ziplock" bag or other covering.

At the receiver, no modification is usually required since it is AC powered and has a line level output.

Selection and Operation of WIRELESS Microphone Systems

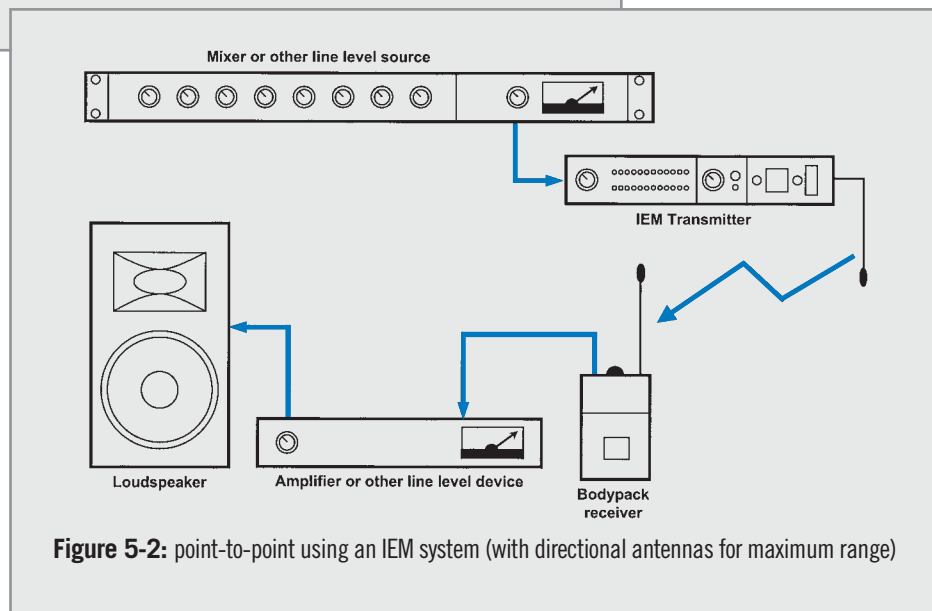
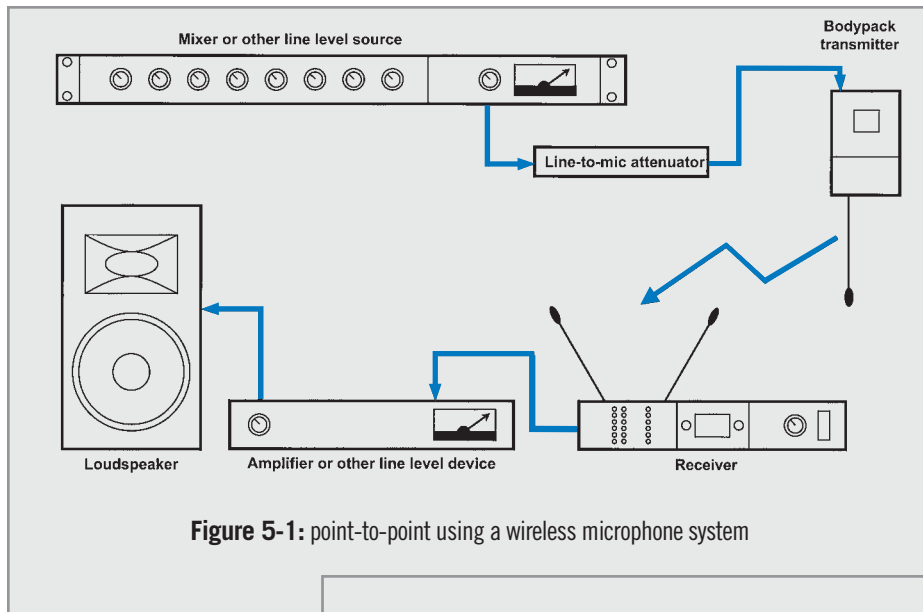

Using wireless in-ear monitors for point-to-point

A wireless in-ear monitor system (IEM) can also be used as a point-to-point system with only one modification at the receiver. At the transmitter, no modification is usually required since it is AC powered and can accept line level signals directly. (See Figure 5-2.)

The modification to the receiver is again for AC power. Many IEM receivers use 9-volt batteries and thus can use a procedure similar to that for the 9-volt transmitters above.

The only other accommodation necessary at the receiver is adapting the stereo (TRS) mini-phone jack output to connect to the destination audio system. This is effectively an unbalanced, -10dBv signal, suitable for most line level input devices. It is recommended that

any receiver limiter be switched off for point-to-point applications in order to obtain the maximum drive level.

Once power and audio connections are made, the IEM receiver should be secured to an elevated location to allow best line of sight to the IEM transmitter. Again, weather protection for the receiver can be provided by a ziplock bag or similar covering.

A significant difference between IEM and wireless microphones for this application is that the stereo IEM can transmit two audio channels (multiplexed) per radio frequency while the wireless microphone system can transmit only one audio channel per radio frequency. If stereo transmission is required IEM is more cost- and spectrum-efficient.

Combining in-ear monitors with wireless microphones for point-to-point

It is sometimes possible to use an IEM transmitter in conjunction with a wireless microphone receiver to create a point-to-point system that is already set up at each end for line-level audio signals and AC power. The principle requirements are that the operating frequencies match and that the audio companding schemes are compatible. Of course only mono audio signals may be transmitted due to the mono nature of the wireless microphone receiver.

The one modification that may be needed is to defeat the squelch circuit of the wireless microphone receiver. Certain IEM transmitters can now be used with compatible wireless microphone receivers without defeating tone-key squelch in the receiver. This is accomplished by a menu setting in the IEM transmitter which matches its tone-key frequency to that of the receiver.

Finally, it may be possible to use a wireless microphone transmitter with an IEM receiver to create an entirely battery-powered point-to-point system. Again, the radio frequencies and companding schemes must match. However, it is probably more efficient to use a wireless microphone with a matching camera-mount type receiver if a completely battery-powered system is the goal.

Antennas

The antennas supplied with most wireless products are omnidirectional. These are suitable for both point-to-point and point-to-multi-point applications. If additional transmission range is required it may be possible to use directional receiving and/or transmitting antenna(s). Note that although diversity receivers are always preferred it may not be necessary (or practical) to use directional antennas on both antenna inputs for point-to-point. Since the transmitter and receiver locations are assumed to be fixed in this application, multipath variations should be minimal once the equipment is set up.

Maximum range of point-to-point wireless

The practical range for most of these systems in point-to-point applications is comparable to their published range in normal usage. For standard wireless systems this ranges from about 150 ft. to 800 ft. depending on various conditions. Directional antennas may boost these ranges by 50%. Good line of sight and the normal precautions for frequency selection are assumed.

The maximum range system employs an IEM transmitter with either an IEM receiver or a suitable wireless microphone receiver. The range advantage of these systems is due to two factors: first, the transmitter power is higher, up to 100mW. This is at least twice the power of most wireless microphone systems. Second, since both the transmitter and the receiver may have detachable antennas, it is possible to use a directional antenna on both the transmitter and the receiver.

In operation, the receiving and transmitting antennas should be pointed toward each other and oriented vertically. Elevation for best line of sight will further improve range. Such a system may be capable of stereo transmission up to 2500 ft and mono operation up to 3500 ft.

If greater distances are required, it can be accomplished by using an additional system as "repeater." That is, at the location of the first receiver a second transmitter is set up to rebroadcast the signal to a more distant second receiver. Of course, each of these additional systems has to be on a different compatible frequency. The practical limit for a repeater system using standard wireless equipment is about 3 "hops" due to increased noise and distortion.

Summary

It is possible to employ wireless systems for point-to-point applications in several ways. Both wireless microphone systems and IEM systems can be used, each with different adaptations. The modifications are primarily for AC powering of battery powered devices and for matching audio signal levels. Special connectors and/or adapters may also be necessary in some cases.

For moderate distance, single channel applications may use wireless microphone systems for good results. Multi-channel, especially stereo, transmission may benefit from the IEM approach. Longer distance uses will require directional antennas for wireless microphone receivers or for IEM transmitters. Maximum range applications can be handled by the dual directional antenna IEM setup or by using multiple systems in a repeater configuration.

Conclusion

To the extent that wireless audio technology is a work in progress, this presentation is also a work in progress. As new radio technologies develop, new applications will arise to take advantage of them. At the same time, new spectrum rules and allocations will likely challenge the capability of wireless equipment suppliers and users to provide successful solutions for those applications.

Implementing successful solutions will rely not just on the programmed "intelligence" built into the equipment but also on the dynamic intelligence of the people specifying and using the equipment. That intelligence comes both from study of the principles underlying the technology and from experience gained by using the technology in real-world situations.

It is hoped that the material presented in this publication will serve as a useful reference on the technical principles of wireless audio transmission, as well as a practical guide to using those principles in a wide variety of applications.

Calculation of Intermodulation Products

The simplest IM products that can occur between any two operating frequencies (f1 and f2) are the sum of the two frequencies and the difference between the two frequencies:

$$f1 + f2 \quad (\text{sum})$$

$$f1 - f2 \quad (\text{difference})$$

If we choose f1 = 200 MHz and f2 = 195 MHz, then:

$$f1 + f2 = 200 + 195 = 395 \text{ MHz (sum)}$$

$$f1 - f2 = 200 - 195 = 5 \text{ MHz (difference)}$$

These IM products are sufficiently far away from the original frequencies that they will generally not cause problems to a third wireless microphone system in the original frequency band.

However, as mentioned earlier, other products of non-linear circuits are multiples of the original frequency. That is, application of a single frequency to a non-linear circuit will produce additional products that are double, triple, quadruple, etc. the original frequency. Fortunately, the strength of these products decreases rapidly as the order (multiplication factor) increases. The practical result is that only the products at two times and three times the original frequency are significant. Since these products then combine as sums and differences with themselves and with the original frequencies, the following additional products can occur:

- (2 x f1)
- (2 x f2)
- (3 x f1)
- (3 x f2)
- (2 x f1) ± f2
- (2 x f2) ± f1
- (3 x f1) ± f2
- (3 x f2) ± f1
- (2 x f1) ± (2 x f2)
- (3 x f1) ± (2 x f2)
- (3 x f2) ± (2 x f1)
- (3 x f1) ± (3 x f2)

The "order" or type of IM product is identified by the particular combination of frequencies that created it. The order of an IM product is the sum of the multipliers (coefficients) of the frequencies in the expressions above. The complete group of possible frequencies (original frequencies, intermodulation products and combinations) that can exist when two systems (at 200 MHz and 195 MHz for this example) are operated simultaneously is thus:

Two-Transmitter Intermodulation Calculation			
Product	Order	Frequency	Significant
f1 (original frequency)	1	200	Yes
f2 (original frequency)	1	195	Yes
2 x f1	2	400	No
2 x f2	2	390	No
f1 + f2	2	395	No
f1 - f2	2	5	No
3 x f1	3	600	No
3 x f2	3	585	No
(2 x f1) + f2	3	595	No
(2 x f1) - f2	3	205	Yes
(2 x f2) + f1	3	580	No
(2 x f2) - f1	3	190	Yes
(3 x f1) + f2	4	795	No
(3 x f1) - f2	4	405	No
(3 x f2) + f1	4	785	No
(3 x f2) - f1	4	385	No
(2 x f1) + (2 x f2)	4	790	No
(2 x f1) - (2 x f2)	4	10	No
(3 x f1) + (2 x f2)	5	990	No
(3 x f1) - (2 x f2)	5	210	Yes
(3 x f2) + (2 x f1)	5	985	No
(3 x f2) - (2 x f1)	5	185	Yes
(3 x f1) + (3 x f2)	6	1185	No
(3 x f1) - (3 x f2)	6	15	No

Though this list of calculated frequency combinations is lengthy, it can be seen that only the IM products at 185, 190, 205 and 210 MHz are in the same general band as the two original operating frequencies. These products will not cause compatibility problems between the two original systems but can interfere with other systems that may be added in this band. In this example, the operating frequency of a third system should be chosen to avoid these four IM frequencies. In general, only odd-order IM products are considered because even-order products typically fall well away from the original frequencies, as shown above. Furthermore, though higher odd-order IM products may also fall near the original frequencies, only 3rd order and 5th order IM products are strong enough to be of concern.

If three or more systems are operated simultaneously, the situation becomes somewhat more complicated but the same principles apply. In addition to the IM products calculated for each pair of frequencies, products due to combinations of three transmitters must also be considered.

For determining compatibility of three frequencies (200 MHz, 195 MHz and 187 MHz in this example) the significant combinations become:

Three-Transmitter Intermodulation Calculation		
Product	Order	Frequency
f1 (original frequency)	1	200
f2 (original frequency)	1	195
f3 (original frequency)	1	187
f1 + f2 - f3	3	208
f1 - f2 + f3	3	192
f2 + f3 - f1	3	182
(2 x f1) - f2	3	205
(2 x f2) - f1	3	190
(2 x f1) - f3	3	213
(2 x f3) - f1	3	174
(2 x f2) - f3	3	203
(2 x f3) - f2	3	179
(3 x f1) - (2 x f2)	5	210
(3 x f2) - (2 x f1)	5	185
(3 x f1) - (2 x f3)	5	226
(3 x f3) - (2 x f1)	5	161
(3 x f2) - (2 x f3)	5	211
(3 x f3) - (2 x f2)	5	171

In this example, the third system frequency (187 MHz) has been chosen to avoid the first two frequencies and their respective IM products. A third system that coincided with an IM product may experience interference when its transmitter is far from its receiver while the first two transmitters are close to each other and to the third receiver.

Note that the addition of the third frequency creates four new third-order, two-transmitter products as well as three third-order, three transmitter products. In general, N transmitters create N x (N-1) third-order, two-transmitter IM products, as well as a number of third-order, three-transmitter products. Thus, the number of available frequencies for additional systems decreases exponentially as the number of systems increases. For this reason, computer programs are used to generate and evaluate compatible sets of frequencies.

5th order two-transmitter IM products are not usually strong enough to cause problems, but may be a factor in cases of extreme transmitter or receiver proximity. 5th order three-transmitter IM products such as (3 x f1) - f2 - f3 and (2 x f1) - (2 x f2) + f3 are generally too weak to be of concern.

Maintaining adequate physical distance between transmitters and between transmitters and receivers will minimize the creation of IM products. The figure below indicates the effect of distance on the amplitude of 3rd order IM products created by two transmitters.

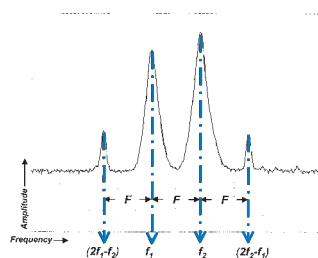

two-transmitter intermodulation

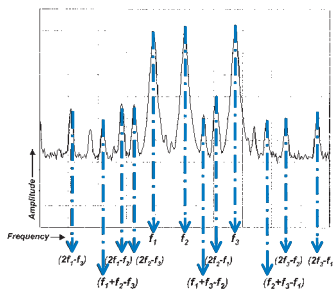

three-transmitter intermodulation

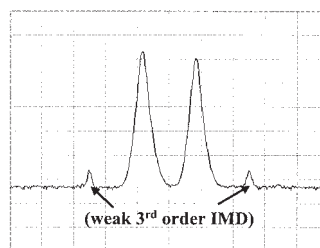

Separation = 8 ft.

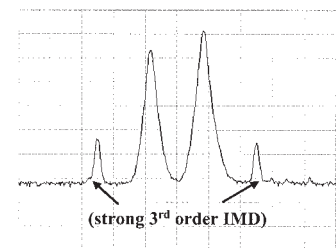

Separation = 4 ft.

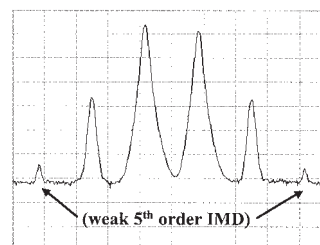

Separation = 1 ft.

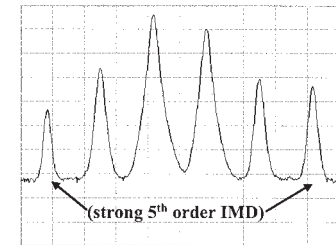

Separation = 0 ft.

two-transmitter IMD strength vs. transmitter separation

US Television Channels

(Analog Components)

Channel	Band	Video	Chroma	Audio
VHF Low Band				
2	54-60	55.25	58.83	59.75
3	60-66	61.25	64.83	65.75
4	66-72	67.25	70.83	71.75
5	76-82	77.25	80.83	81.75
6	82-88	83.25	86.83	87.75
VHF High Band				
7	174-180	175.25	178.83	179.75
8	180-186	181.25	184.83	185.75
9	186-192	187.25	190.83	191.75
10	192-198	193.25	196.83	197.75
11	198-204	199.25	202.83	203.75
12	204-210	205.25	208.83	209.75
13	210-216	211.25	214.83	215.75
UHF Band				
14	470-476	471.25	474.83	475.75
15	476-482	477.25	480.83	481.75
16	482-488	483.25	486.83	487.75
17	488-494	489.25	492.83	493.75
18	494-500	495.25	498.83	499.75
19	500-506	501.25	504.83	505.75
20	506-512	507.25	510.83	511.75
21	512-518	513.25	516.83	517.75
22	518-524	519.25	522.83	523.75
23	524-530	525.25	528.83	529.75
24	530-536	531.25	534.83	535.75
25	536-542	537.25	540.83	541.75
26	542-548	543.25	546.83	547.75
27	548-554	549.25	552.83	553.75
28	554-560	555.25	558.83	559.75
29	560-566	561.25	564.83	565.75
30	566-572	567.25	570.83	571.75
31	572-578	573.25	576.83	577.75
32	578-584	579.25	582.83	583.75
33	584-590	585.25	588.83	589.75
34	590-596	591.25	594.83	595.75
35	596-602	597.25	600.83	601.75
36	602-608	603.25	606.83	607.75
37	608-614	Reserved for radio-astronomy		
38	614-620	615.25	618.83	619.75
39	620-626	621.25	624.83	625.75
40	626-632	627.25	630.83	631.75
41	632-638	633.25	636.83	637.75
42	638-644	639.25	642.83	643.75
43	644-650	645.25	648.83	649.74
44	650-656	651.25	654.83	655.75
45	656-662	657.25	660.83	661.75
46	662-668	663.25	666.83	667.75
47	668-674	669.25	672.83	673.75
48	674-680	675.25	678.83	679.75
49	680-686	681.25	684.83	685.75
50	686-692	687.25	690.83	691.75
51	692-698	693.25	696.83	697.75

Channel	Band	Video	Chroma	Audio
Reallocated				
52	698-704	699.25	702.83	703.75
53	704-710	705.25	708.83	709.75
54	710-716	711.25	714.83	715.75
55	716-722	717.25	720.83	721.75
56	722-728	723.25	726.83	727.75
57	728-734	729.25	732.83	733.75
58	734-740	735.25	738.83	739.75
59	740-746	741.25	744.83	745.75
60	746-752	747.25	750.83	751.75
61	752-758	753.25	756.83	757.75
62	758-764	759.25	762.83	763.75
63	764-770	765.25	768.83	769.75
64	770-776	771.25	774.83	775.75
65	776-782	777.25	780.83	781.75
66	782-788	783.25	786.83	787.75
67	788-794	789.25	792.83	793.75
68	794-800	795.25	798.83	799.75
69	800-806	801.25	804.83	805.75

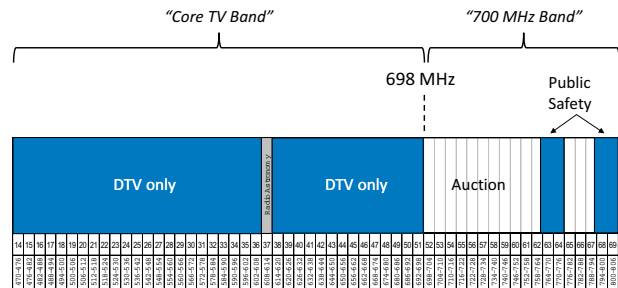

DTV transition and 700 MHz Re-Allocation

Absorption

The weakening of radio wave strength by losses in various materials

ADC

Analog-to-digital converter, also abbreviated A/D

AF

Audio frequencies, typically 20-20,000 Hz.

AM

Amplitude modulation

Ambient

Local or background, ie. ambient noise

Amplitude

Magnitude or strength of a signal or wave

AM rejection

Ability of an FM receiver to reject signals from AM transmitters and/or AM noise from electrical devices or natural sources

Antenna

Electrical circuit element that transmits or receives radio waves

Antenna gain

Measure of antenna efficiency compared to a reference antenna, ie. dBi = gain relative to theoretical isotropic (spherical omnidirectional) antenna

Antenna splitter

A device for electrically matching a single antenna to multiple receivers

ASK

Amplitude shift keying

Attenuation

Measure of the loss of amplitude of a signal

Band

A defined portion of the frequency spectrum

Bandwidth

A measure of the frequency range of a signal or device

Base frequency

The actual frequency of a crystal oscillator, usually then multiplied to some higher operating frequency

Bias voltage

A fixed DC voltage which establishes the operating characteristic of a circuit element such as a transistor

Bit

Smallest digital data element, has a value of "0" or "1"

Bodypack

Transmitter style which can be worn on the body

Capture

The effect of a strong FM signal suppressing weaker signals at the receiver

Carrier

The basic or unmodulated radio wave

Cascade

Active antenna output port of receiver or antenna splitter than can feed another receiver or antenna splitter

Codec

Software algorithm for data compression and decompression (code-decode)

Compander

A two-step noise reduction system consisting of a compressor in the transmitter and an expander in the receiver

Compressor

A circuit which reduces the dynamic range of a signal by a fixed ratio, typically 2:1 in a compander system

DAC

Digital-to-analog converter, also abbreviated D/A

dBm

Ratio of power levels relative to one milliwatt, ie. 0dBm = 1mW, 10dBm = 10mW

DECT

Digital Enhanced Cordless Telecommunications, standard for digital cordless telephones, ie. 1920-1930 MHz in the US, different bands in other countries

De-emphasis

A fixed equalization which typically rolls off high frequencies in the second step of a two-step noise reduction process

Demodulation

The recovery of the original modulating information from a radio signal

Detector

The circuitry that performs demodulation

Deviation

The maximum frequency variation of an FM signal

Diffraction

The bending or partial reflection of radio waves by metal objects

Dipole

An antenna which is made up of two active elements

Direct

Not reflected

Direct sequence spreading

Spread spectrum technique using continuous, synchronized deviation changes across a wide frequency range

Distortion

Any unwanted difference between the original and final version of a signal

Diversity

Scheme that relies on statistical decorrelation of the same signal received at multiple locations to minimize signal fading and multipath dropout, also called space diversity or antenna diversity

Dropout

The complete loss of received signal due to multipath interference

DSP

Digital Signal Processor, used in digital and hybrid radio circuits

Dynamic range

Maximum amplitude range of a signal or device, generally the difference between the strongest and weakest signals that occur or that the device can handle

Encryption

Encoding a transmitted signal so that it can be decoded only with a unique digital "key"

EM

Electromagnetic

ERP

Effective radiated power, the actual power radiated by a transmitter antenna

Expander

A circuit which expands the dynamic range of a signal by a finite ratio, typically 1:2 in a compander system

Fading

Loss of signal strength due to distance or obstacles in the signal path

FCC

Federal Communications Commission, US radio regulatory agency

Field

A distribution of energy in space, ie. electric, magnetic, sound

Field strength

The amplitude of a field at a given point, measured in volts per meter for electric energy

FM

Frequency modulation

Frequency

A measure of the rate of variation of a wave or signal

Frequency agile

Having the ability to change frequencies: tuneable

Frequency diversity

Scheme that relies on statistical decorrelation of the same signal transmitted and received at multiple frequencies to minimize RF interference effects

Frequency hopping

Spread spectrum technique using continuous, synchronized frequency changes across a wide frequency range

Frequency response

Variation in amplitude of a signal over a range of frequencies

Front end

Initial filter stage of a receiver

FSK

Frequency shift keying

Gain

Amplification

Geolocation

Ability of a TVBD to determine its geographic location

Ground plane

Electrical approximation of a zero-potential reflective surface at the base of an antenna

GSM

Global Systems for Mobile Communications, mobile telephone standard, ie. 850 Mz and 1900 MHz in the US, different bands in other countries

Handheld

Transmitter type which can be held in the hand

Hash

A term for audible radio interference

Helical

Wideband directional antenna consisting of a single circularly-polarized element

Heterodyne

To combine signals of various frequency in a manner that produces additional signals at frequencies which are sums and differences of the original frequencies

Hybrid

Radio design combining digital audio processing with analog transmission

IEM

In ear monitor

IF

Intermediate frequency, a lower radio frequency (typically 10.7 MHz) found in the middle stages of a receiver

IFB

Interruptible fold back, a cueing system used in broadcast

IF filter

A narrow, band-pass filter tuned to the intermediate frequency (IF)

IM

Intermodulation, frequencies produced by combinations of other frequencies in non-linear devices

IMD

Intermodulation distortion (another name for IM)

IM rejection

Ability of a receiver to reject IM products

Image

An interfering frequency which differs from the desired frequency by twice the intermediate frequency (IF)

Image rejection

The ability of a receiver to reject interference from an image frequency (determined by the front end)

Impedance

A measure of the resistance to current flow in a circuit (may vary with frequency)

Indirect

Reflected or diffracted

Intercept (third order)

A measure of the ability of a radio input stage to handle high signal levels without overload or distortion

Inverse square law

Mathematical relationship in which one quantity is inversely proportional to the square of another quantity, ie. signal strength decreases according to the distance squared

Latency

Signal delay that occurs in digital systems due to finite speed of DSP, ADC, and DAC circuits

Level

The amplitude or strength of a signal

LF

Low frequency

Limiter

A circuit which limits the maximum level of a signal

Line-of-sight

Preferred wireless operating condition where transmit antenna is visible to receive antenna with no obstruction

LO

Local oscillator, in a receiver it is tuned to a frequency which is offset from the operating frequency by an amount equal to the intermediate frequency (IF)

Log periodic

Wideband directional antenna consisting of multiple logarithmic-spaced dipole elements

Loss

Decrease in signal strength during transmission, propagation or reception

Medium

Substance through which a wave propagates; for radio it may be vacuum, gas, liquid or solid; wave speed is affected by medium

Mixer

Circuitry in a receiver that combines the received signal with the local oscillator to produce the IF signal

Modulating frequency

The frequency of the audio signal used for modulation of the radio wave

Modulation

Variation of a wave parameter (such as amplitude or frequency) to carry information

Modulation noise

Low level noise which accompanies the audio signal in a companded wireless microphone system

Multipath

Reflection of radio waves that causes fluctuation in received signal strength

Narrow band

An FM signal in which the deviation is much less than the modulating frequency

Noise

Undesirable random audio or radio energy

Operating frequency

The final output frequency of a transmitter or the tuned frequency of a receiver

Oscillator

A circuit that produces a continuous periodic output

Phase-lock-loop (PLL)

A circuit which maintains a desired frequency by means of a self-correcting feedback technique

Plug-on

A transmitter type which may be attached directly to a microphone

PM

Phase modulation

Point-to-point

Transmission of signal from one fixed location to another fixed location

Polarization

The orientation of the electric field component of a radio wave

Power

Usually refers to the RF power delivered to the transmitter antenna, measured in milliwatts (mW)

Pre-emphasis

A fixed equalization which typically boosts high frequencies in the first part of a two-step noise reduction process

Propagation

Ability of radio signal to travel a significant distance

Protected channels

Designated TVBD-free TV channels at a given location, defined by FCC rules

PSK

Phase shift keying

QPSK

Quadrature Phase Shift Key, a digital transmission symbol coding with four possible values

Quadrature

Phase relationship of 90° between two signals

Quieting

The suppression of radio noise in a receiver when the desired signal is picked up at a certain strength

Radio waves

Electromagnetic waves which propagate a significant distance from the source

RCV

Abbreviation for Receiver

Receiver

Device which is sensitive to radio signals and recovers information from them

Reciprocal

Property of a passive antenna to operate equivalently either in transmit or in receive mode

Reflection

Retransmission of incident radio waves by metal objects

RF

Radio frequency, generally taken to mean well above 20,000 Hz

RFI

Radio frequency interference

Sampling

Conversion of a continuous audio waveform into discrete digital values

Selectivity

Measure of a receiver's ability to discriminate between closely-spaced frequencies

Sensitivity

Measure of a receiver's ability to respond to weak radio signals

Shadow

Blocking of radio waves by reflective or absorptive (lossy) objects

Shift keying

Modulation of a radio wave in discrete steps, used for digital signal transmission

Signal-to-noise ratio

Overall useable amplitude range of a signal or device, generally the difference between some reference level and the residual noise level

SINAD

A measure of receiver sensitivity stated as the RF signal strength required for given minimum signal-to-noise + distortion ratio

Spread spectrum

A radio transmission technique which spreads the energy of the signal over a wide frequency range rather than concentrating it at one frequency

Spurious emissions (spur)

Residual output from crystal-controlled transmitters occurring at frequencies that are offset from the operating frequency by multiples of the crystal base frequency

Spurious rejection

The ability of a receiver to reject spurious emissions

Squelch

Circuit in a receiver that mutes the audio output in the absence of the desired transmitter signal

Spectrum

A range of discrete frequencies

STL

Studio Transmitter Link, in the US: 944-952 MHz

Superheterodyne

In a receiver, the technique of filtering the received signal to eliminate possible image frequencies and then mixing the received signal frequency with the local oscillator (LO) to produce the intermediate frequency (IF)

Symbol

Digital data element that contains more than one bit, ie. a QPSK symbol contains two bits

Transmitter

Device which converts information to a radio signal

TVBD

Television Band Device, sometimes called White Space Device

TX

Abbreviation for transmitter

UHF

Ultra high frequency (about 300 - 3000 MHz)

VCA

Voltage controlled amplifier, used in audio compressor and expander circuits

VCO

Voltage controlled oscillator, used in radio tuning circuits

VHF

Very high frequency (about 30 - 300 MHz)

Wavelength

The physical distance between successive complete cycles of a wave, inversely proportional to frequency, dependent on properties of medium

White Space

Unoccupied space between active TV channels

Wideband

An FM signal in which the deviation is much greater than the modulating frequency

Chapter 1

Figure 1-1:	radio wave	5
Figure 1-2:	frequency vs. wavelength	5
Figure 1-3:	the wave equation	6
Figure 1-4:	propagation: wavelength vs. openings	6
Figure 1-5:	propagation: wavelength vs. obstacles	6
Figure 1-6:	amplitude modulation (AM)	7
Figure 1-7:	frequency modulation (FM)	7

Chapter 2

Figure 2-1:	general radio system diagram	8
Figure 2-2:	examples of transmitters (handheld, bodypack, plug-on)	9
Figure 2-3:	general transmitter block diagram	10
Figure 2-4a:	pre-emphasis in transmitter	10
Figure 2-4b:	de-emphasis in transmitter	10
Figure 2-5a:	compander (2:1, fixed rate)	11
Figure 2-5b:	compander (variable)	11
Figure 2-6a:	unmodulated FM signal spectrum	11
Figure 2-6b:	modulated FM signal spectrum	11
Figure 2-7:	crystal-controlled transmitter	12
Figure 2-8:	frequency-synthesized transmitter	12
Figure 2-9:	receiver examples (fixed, portable)	12
Figure 2-10:	general receiver block diagram	12
Figure 2-11:	track tuning front-end filter	13
Figure 2-12a:	single conversion, crystal-controlled receiver	13
Figure 2-12b:	single conversion, frequency-synthesized receiver	13
Figure 2-13:	receiver, filter characteristic	13
Figure 2-14a:	double conversion, crystal-controlled receiver	14
Figure 2-14b:	double conversion, frequency-synthesized receiver	14
Figure 2-15:	threshold squelch	15
Figure 2-16:	noise squelch	15
Figure 2-17:	examples of receivers	15
Figure 2-18:	multipath	16
Figure 2-19:	signal level at two antennas with multipath	16
Figure 2-20:	passive antenna combining	17
Figure 2-21:	antenna phase switching	17
Figure 2-22:	antenna switching	17
Figure 2-23:	receiver switching	17
Figure 2-24:	receiver combining	17
Figure 2-25:	transmitter antenna examples (trailing wire, rubber-duckie, internal)	18
Figure 2-26:	wideband omnidirectional antenna	19
Figure 2-27:	1/4 wave and 1/2 wave antennas UHF range	19
Figure 2-28:	examples of remote receiver antennas (1/2 wave with amplifier, log periodic, helical)	20
Figure 2-29:	log periodic antenna polar pattern	20
Figure 2-30:	comparison of coaxial cable types	21
Figure 2-31:	coaxial antenna cable loss at VHF and UHF frequencies	21

Figure 2-32:	multi-room antenna distribution	22
Figure 2-33:	passive antenna distribution	22
Figure 2-34a:	active antenna distribution (one level)	22
Figure 2-34b:	active antenna distribution (two level)	22
Figure 2-35:	antenna amplifiers	22

Chapter 3

Figure 3-1:	wireless frequency bands in the United States	23
Figure 3-2:	VHF allocations in the United States (30-300 MHz)	24
Figure 3-3:	UHF allocations in the United States (300 MHz - 3GHz)	25
Figure 3-4:	linear vs. non-linear circuits	27
Figure 3-5:	two-transmitter intermodulation	27
Figure 3-6:	three-transmitter intermodulation	27
Figure 3-7:	two-transmitter IMD strength vs. transmitter separation	28
Figure 3-8:	local oscillator (LO) interference	28
Figure 3-9a:	image frequency interference (low-side injection)	29
Figure 3-9b:	image frequency interference (high-side injection)	29
Figure 3-10:	crystal harmonics	30
Figure 3-11a:	analog television channel spectrum	31
Figure 3-11b:	digital television channel spectrum (DTV)	31
Figure 3-12:	DTV transition and 700 MHz re-allocation	31
Figure 3-13:	loss vs. distance vs. frequency	35
Figure 3-14:	frequency hopping spectrum	36
Figure 3-15:	direct sequence spectrum	36
Figure 3-16:	2FSK	37
Figure 3-17:	QPSK	37
Figure 3-18:	frequency-synthesized digital transmitter	39
Figure 3-19:	frequency-synthesized digital receiver	39
Figure 3-20:	international wireless frequencies	39

Chapter 4

Figure 4-1:	examples of transmitters (handheld, bodypack, plug-on)	41
Figure 4-2:	examples of input connectors (1/4", mini XLR, Lemo)	42
Figure 4-3:	proper and improper antenna positions	43
Figure 4-4:	receiver examples (fixed, portable)	43
Figure 4-5:	examples of receiver audio output and antenna input connectors	44
Figure 4-6:	proper and improper antenna and receiver placement	45
Figure 4-7:	alkaline vs. rechargeable batteries	47
Figure 4-8:	Shure Axient Wireless System	48

Chapter 5

Figure 5-1:	point-to-point using a wireless microphone system	56
Figure 5-2:	point-to-point using an IEM system (with directional antennas for maximum range)	56

BIOGRAPHY: Tim Vear

Tim is a native of the south side of Chicago (Go White Sox!). A lifelong interest in both entertainment and science has led to the field of audio as his choice for combining these interests in a useful way. Prior to joining Shure he worked as an engineer for recording, radio and live sound, operated his own recording studio and sound company, and continues to play music professionally. He holds a BS degree in Aeronautical and Astronautical Engineering, with a minor in Electrical Engineering, from the University of Illinois, Urbana-Champaign. While at the University, Tim also worked as chief technician with both the Speech and Hearing Science and Linguistics departments.

Since joining Shure in 1984, Tim has served in a technical support and training capacity for multiple departments. He has been active in product and applications education for Shure customers, dealers, and installers, as well as company staff. His major goal has been to increase the understanding of quality audio by presenting technical information in a way that is thorough but still very accessible. Tim's particular emphasis is on the contribution of proper selection and technique for both wired and wireless microphones.

In addition, Tim has done technical presentations for many industry organizations (NAB, NAMM, AES, and SBE), as well as for US government entities such as the White House Communication Agency and the US Air Force. Through His international assignments he has been fortunate to be able to deliver presentations in more than twenty countries and on all but one of the continents (still waiting for an offer from Antarctica...).

He has provided specific applications assistance to various performing artists including the Rolling Stones and U2, for theme parks such as Disney and Universal Studios, and performance groups such as Cirque du Soleil.

While at Shure, Tim has authored several educational booklets including "Selection and Operation of Wireless Microphone Systems" and "Audio Systems Guide for Houses of Worship."

His articles have also appeared in Recording Engineer Producer, Live Sound Magazine, Pro AV, Technologies for Worship, and Church Sound Magazine.

I would like to cite the following individuals at Shure Inc. for their extreme patience and invaluable assistance:

Edgar Reihl

Ahren Hartman

David Rochman

(and Stuart Baum, too!)

Thanks a ton!

Additional Shure Publications Available:

Printed and electronic versions of the following guides are available free of charge. To obtain your complimentary copies, call one of the phone numbers listed below or visit www.shure.com.

- Selection and Operation of Personal Monitor Systems
- Audio Systems Guide for Houses of Worship
- Microphone Techniques for Studio Recording
- Microphone Techniques for Live Sound Reinforcement

Our Dedication to Quality Products

Shure offers a complete line of microphones and wireless microphone systems for everyone from first-time users to professionals in the music industry—for nearly every possible application.

For over eight decades, the Shure name has been synonymous with quality audio.

All Shure products are designed to provide consistent, high-quality performance under the most extreme real-life operating conditions.

SHURE[®]
LEGENDARY
PERFORMANCE™

**United States, Canada,
Latin America, Caribbean:**
Shure Incorporated
5800 West Touhy Avenue
Niles, IL 60714-4608 USA

Phone: +1 847-600-2000
Fax: +1 847-600-1212 (USA)
Fax: +1 847-600-6446
Email: info@shure.com
www.shure.com

©2014 Shure Incorporated

Europe, Middle East, Africa:
Shure Europe GmbH
Jakob-Dieffenbacher-Str. 12,
75031 Eppingen, Germany

Phone: +49-7262-92490
Fax: +49-7262-9249114
Email: info@shure.de
www.shure.eu

AL25573 8/14

Asia, Pacific:
Shure Asia Limited
22/F, 625 King's Road
North Point, Island East
Hong Kong

Phone: +852-2893-4290
Fax: +852-2893-4055
Email: info@shure.com.hk
www.shureasia.com